

Studies of matter at extreme conditions

Giuliana Aquilanti

giuliana.aquilanti@elettra.eu

As far as we know, human beings and other biological organisms exist in the universe only on or near the surface of the Earth, where the physical conditions permit the existence of self-replicating long-chain molecules



Binding takes place when the individual atoms are close enough together that the outer valence electrons of each atom can experience the potential well of the neighboring atom's nucleus as comparable to the potential well of its own atom's nucleus

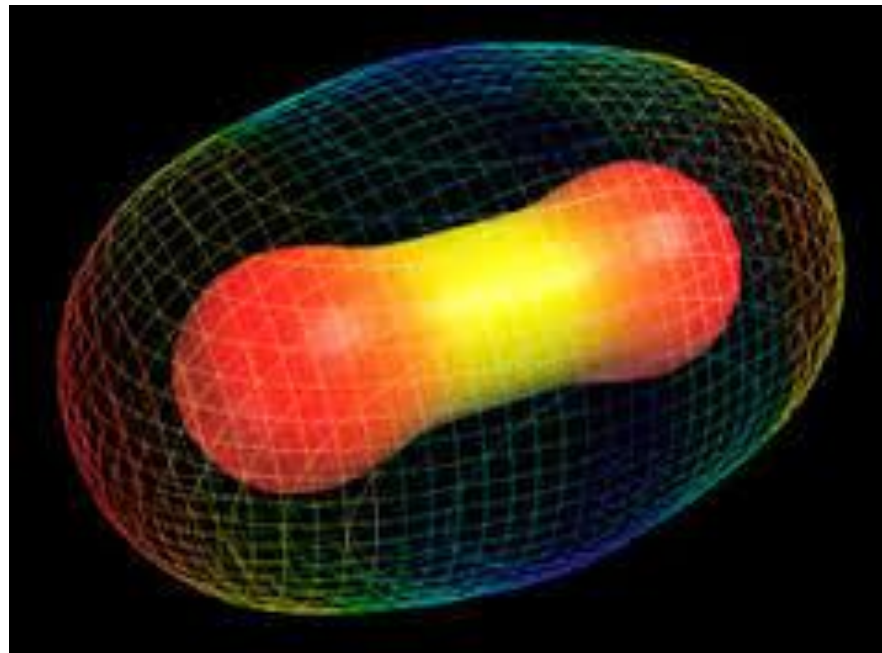

- ❖ Electron binding energy: few eV
- ❖ Binding energy of typical covalent carbon–carbon molecular bond: 4 eV
- ❖ In graphite, potential energy of adjacent planes of carbon atoms: 0.05 eV per carbon atom
 - ❖ This energy E corresponds to a temperature $T = E/k \approx 600$ K

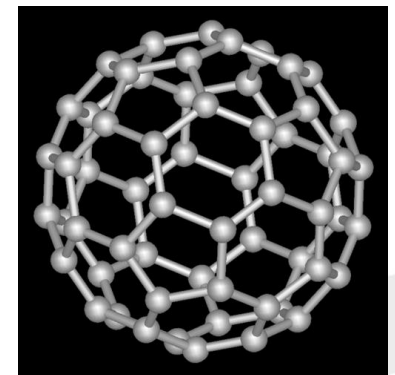

“Ambient conditions”



- ◆ The surface of the Earth, at an average temperature of 300 K and an average pressure of 1 atm = 0.1 MPa, is at ideal conditions for the existence of stable large molecular structures

“Extreme conditions”

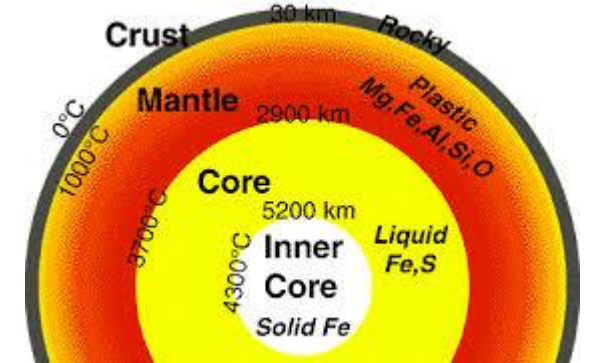
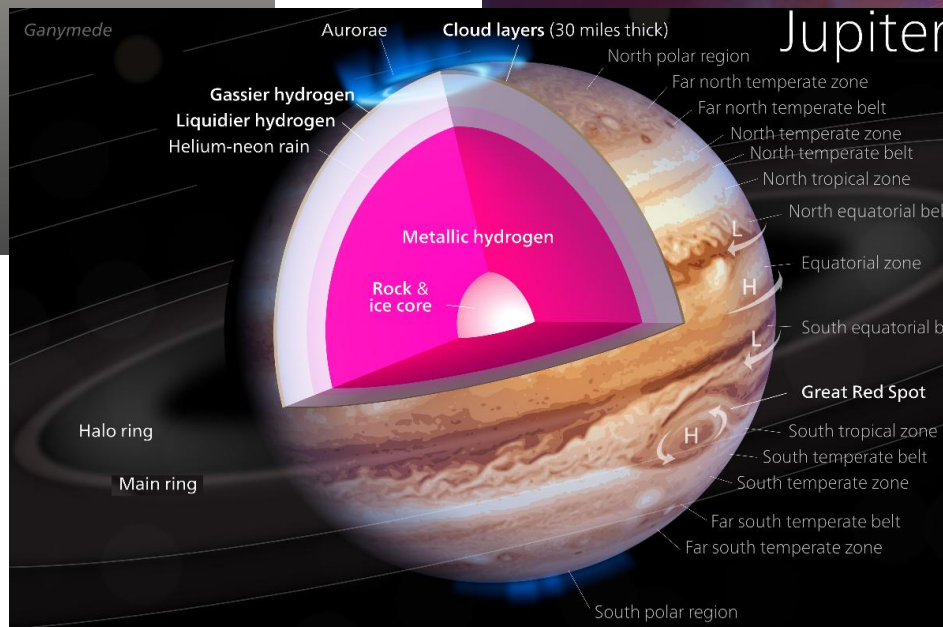
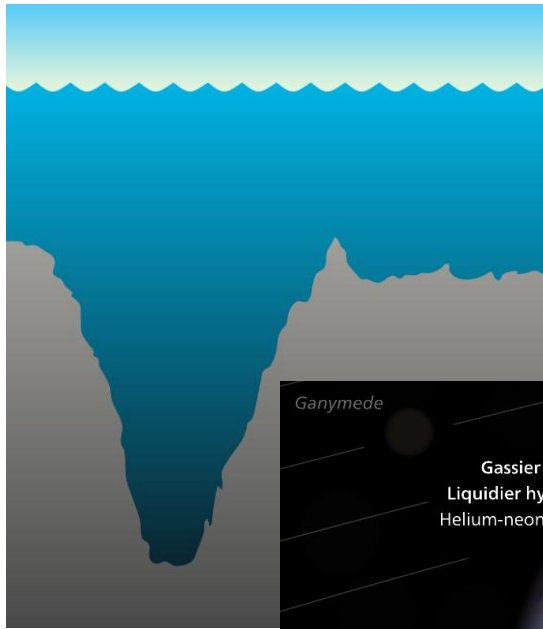

At much higher temperatures or pressures, matter will likely be in an entirely different physical state, and will behave differently

- ◆ All physical (and chemical) transformations are controlled by:
 - ◆ Temperature
 - ◆ Pressure
 - ◆ Chemical potential
- ◆ Acting on these external or internal parameters it is possible to affect the equilibrium composition of the systems and the kinetics of the transformation

- ◆ Chemical events occur as bonds are broken and other are formed, with the nuclei circumventing energetic barriers
- ◆ Temperature accelerates the motion in crossing these barriers
- ◆ Pressure changes the structure of the barriers height: so while they are decreased in some cases, they are increased in others.

- ◆ Of the common thermodynamic variables pressure and temperature, it is temperature that has played by far the most prominent role in probing condensed matter and in our fundamental understanding of it



Robert Boyle (1622-1691)

*Touching
the Spring of the Air, and its effects*

*"the pressure of the air might
have an interest in more
phenomena than men have
hitherto thought"*



Pressures in the universe

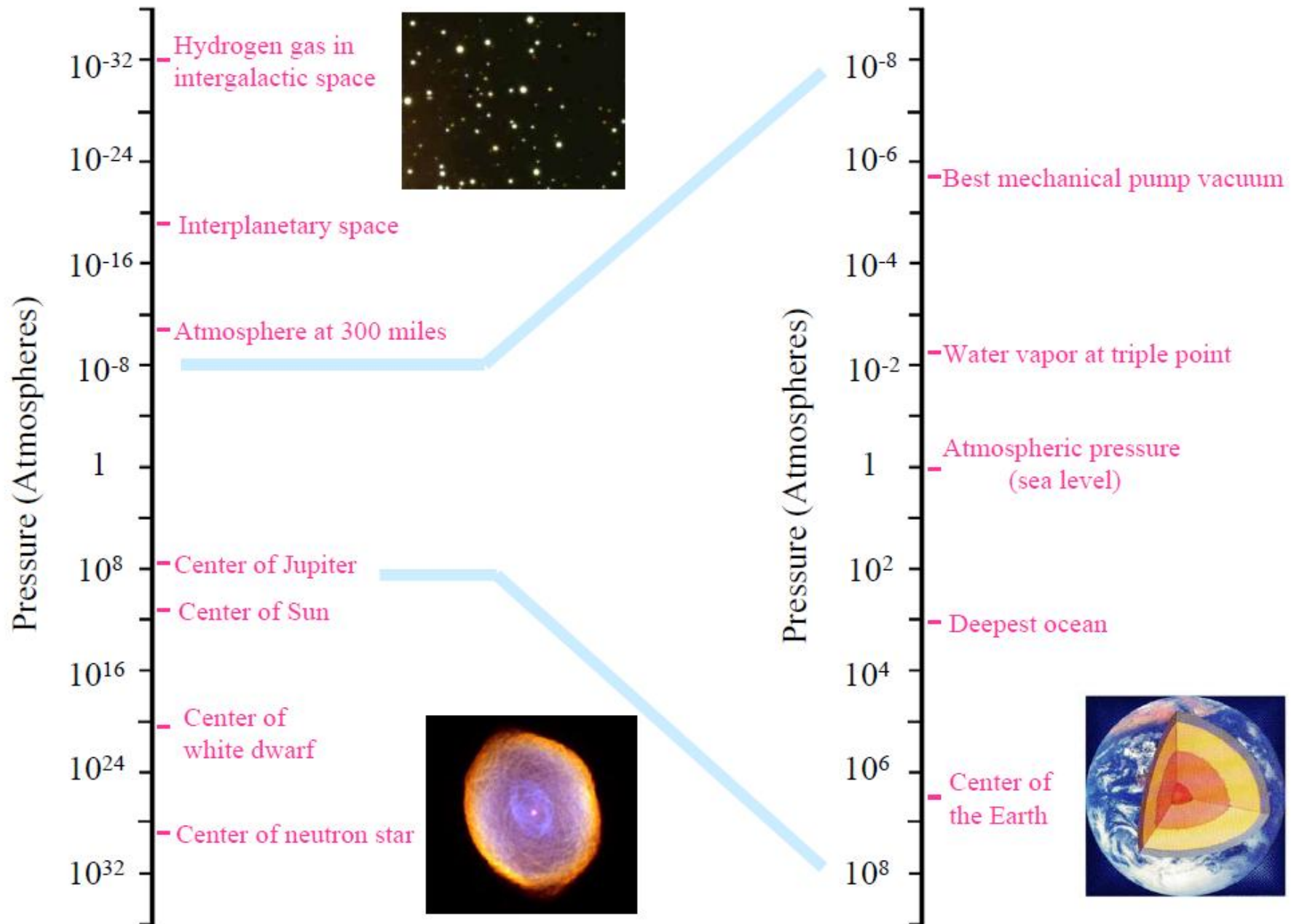



- ◆ Introduction
- ◆ Effects of pressure
 - ◆ Insulator to metal transitions
 - ◆ Metal to insulator transitions
 - ◆ Effects on magnetism
 - ◆ Structural phase transitions
- ◆ High pressure and Earth's science
- ◆ Tools and methods
- ◆ Examples of high pressure research using XAS
 - ◆ Polyamorphism in glassy GeO_2
 - ◆ Melting of iron at megabar pressures
 - ◆ Revealing Earth's interior
- ◆ Bibliography

At 1 Megabar

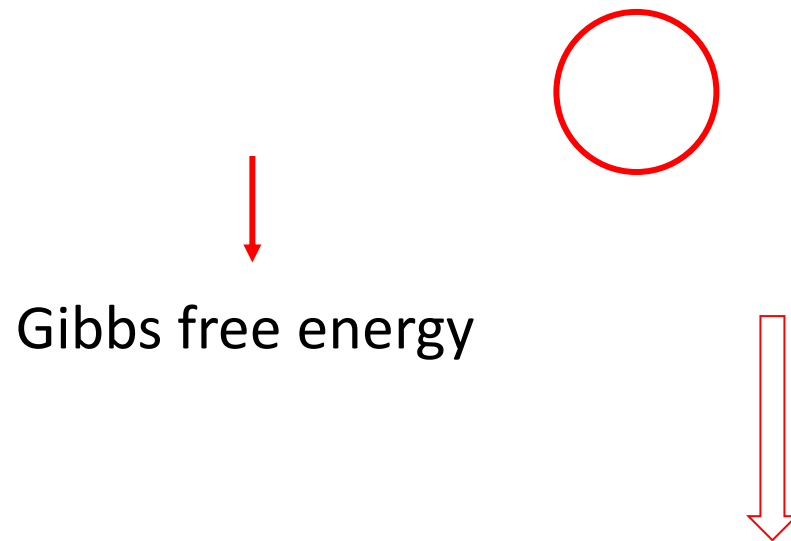

Gibbs free energy

New bonds creates, existing bonds deformed

At 2 Megabar

Typical volume reduction of 1.5 – 5
(the atoms are driven close together)



Shrinking of the distance along one direction
(if isotropic) of 1.1 -1.7

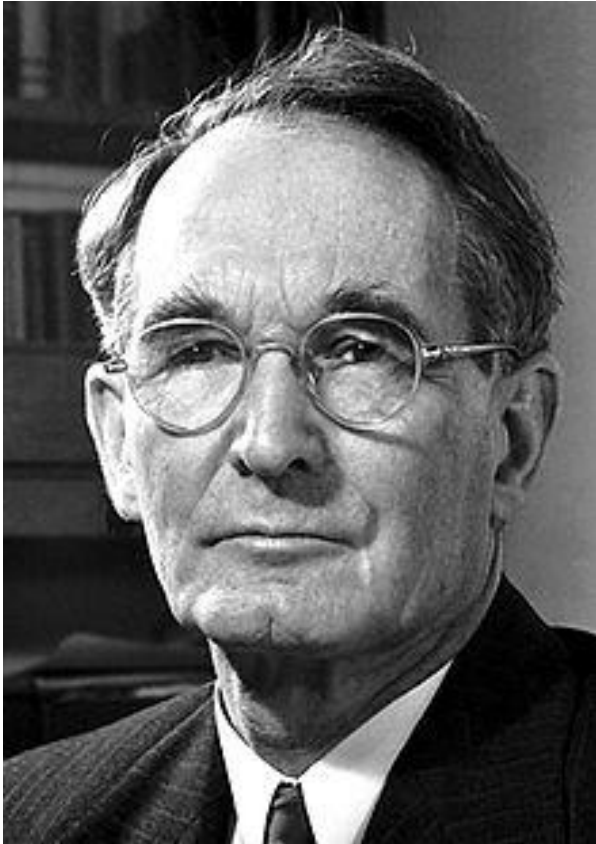

Percy W. Bridgman (1882-1961)

Nobel laureate in physics (1946)

“This compression offers a route to "breaking down" the electronic structure of the atoms themselves and to the possibility of entirely different bulk properties”

- ◆ Through application of pressure, we can bring about one of the most basic of all changes, the crossing of the “great divide” from insulators to metals
- ◆ Pressure-induced insulator-to-metal transitions have been documented in a long list of materials and over a broad range of pressures

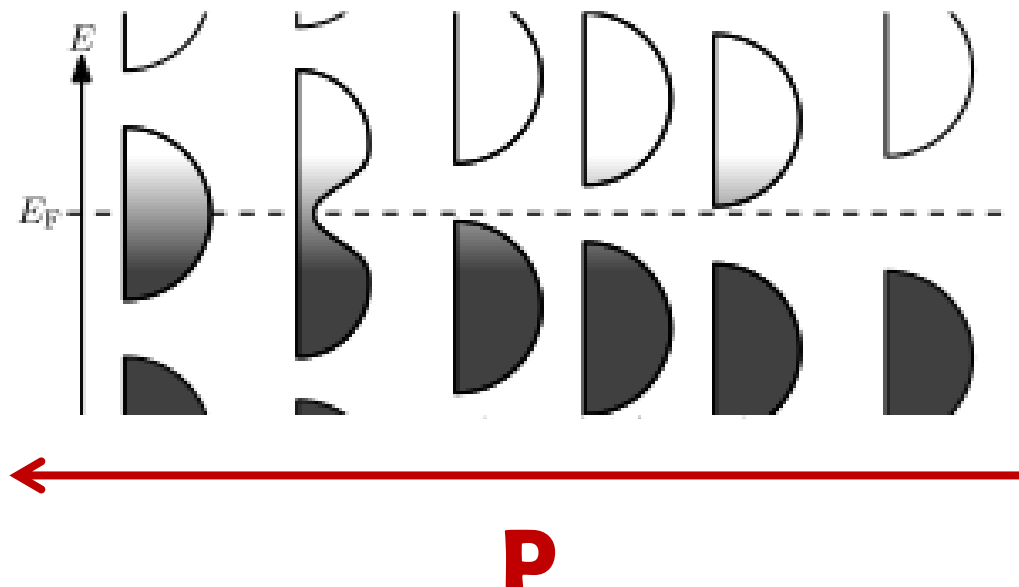

Silicon

J. Phys. Chem. Solids Pergamon Press 1962, Vol. 23, pp. 451–456. Printed in Great Britain.

PRESSURE INDUCED PHASE TRANSITIONS IN SILICON, GERMANIUM AND SOME III-V COMPOUNDS*

S. MINOMURA and H. G. DRICKAMER

Department of Chemistry and Chemical Engineering
University of Illinois, Urbana, Illinois

(Received 25 September 1961)

Abstract—Pressure induced phase transitions to a conducting state have been found for silicon (195–200 kbars), germanium (120–125 kbars), GaAs (245–250 kbars, 275–280 kbars), GaSb (80–100 kbars), InAs (100 kbars), InP (125–130 kbars) and AlSb (115–125 kbars). No transition occurred in GaP to 550 kbars. Although it cannot be definitely proven, it is the author's feeling that, with the exception of GaAs, all transitions are solid–solid transitions, apparently to a metallic state. For GaAs, it is postulated that the first transition involves melting to a metallic liquid, while the second transition constitutes the freezing of the liquid.

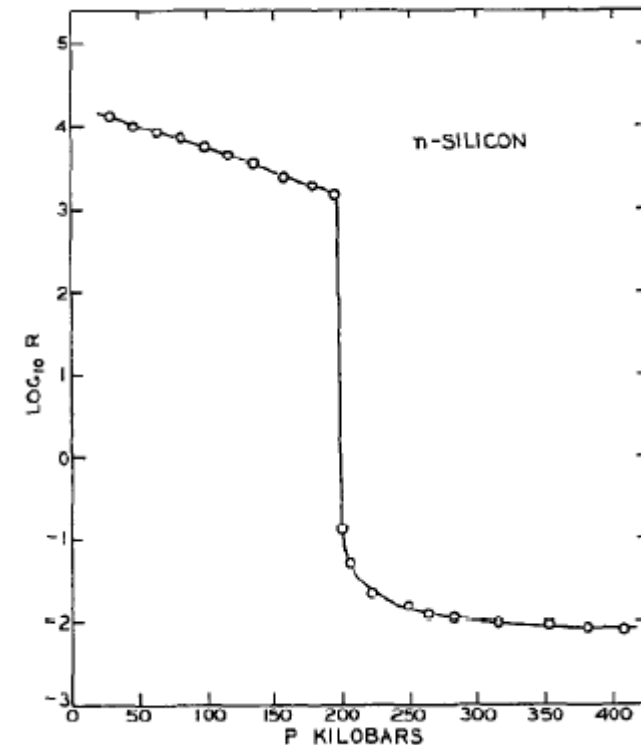
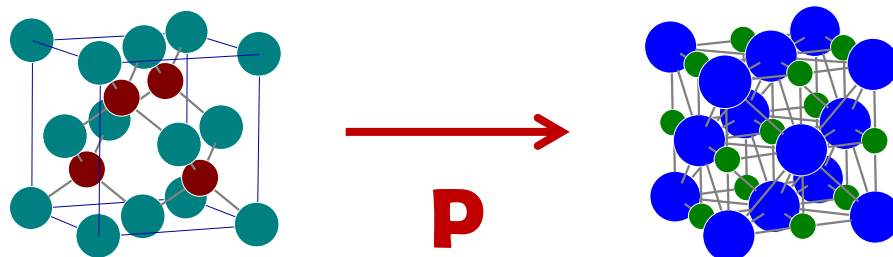
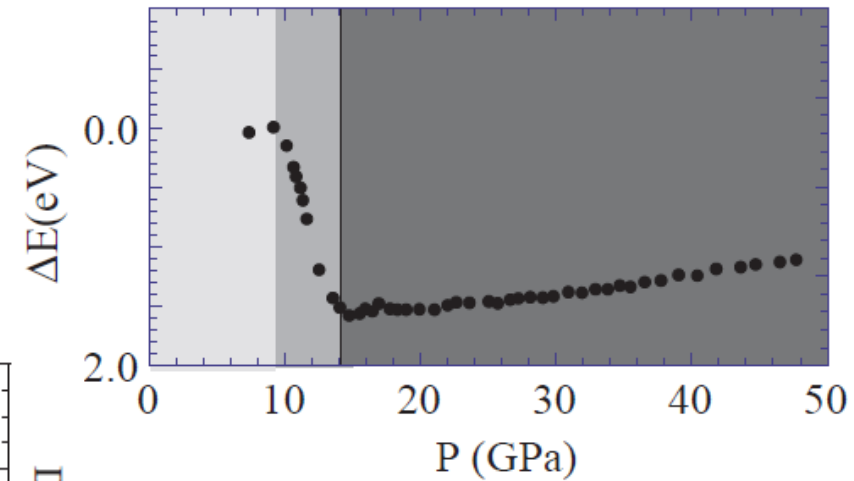
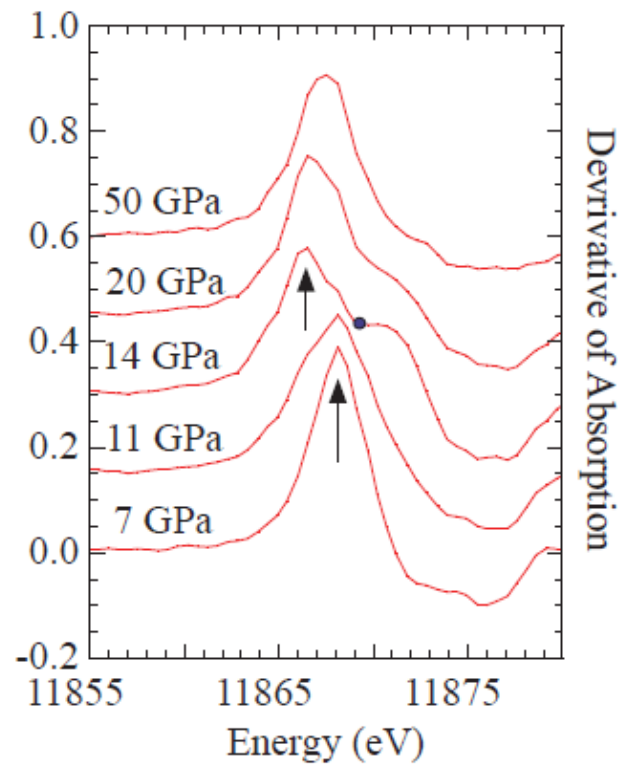
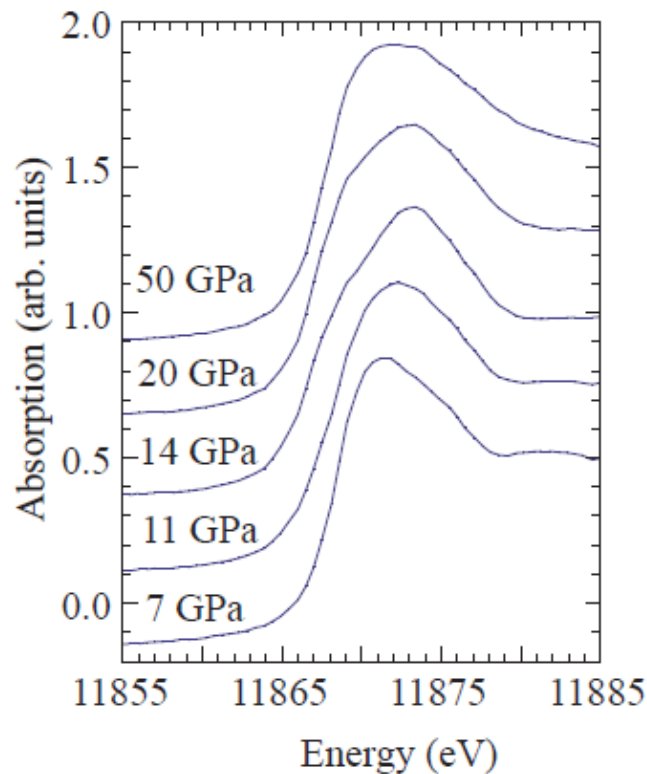

FIG. 1. Resistance vs. pressure—*n*-Silicon.



III-V compounds: InAs



Diatomic molecular solids: the halogens (Br_2)

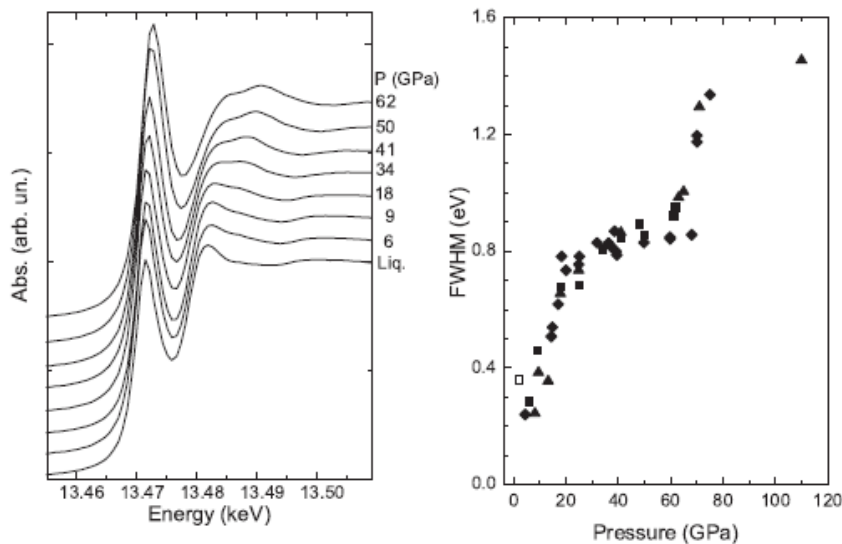
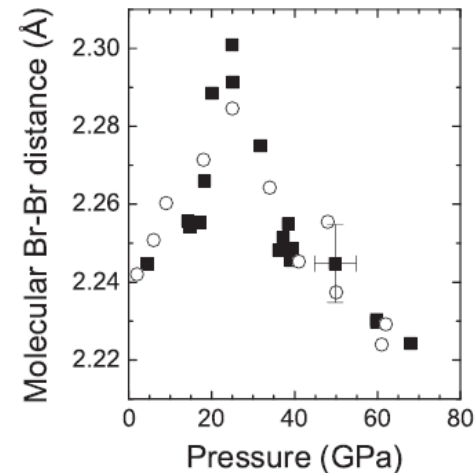
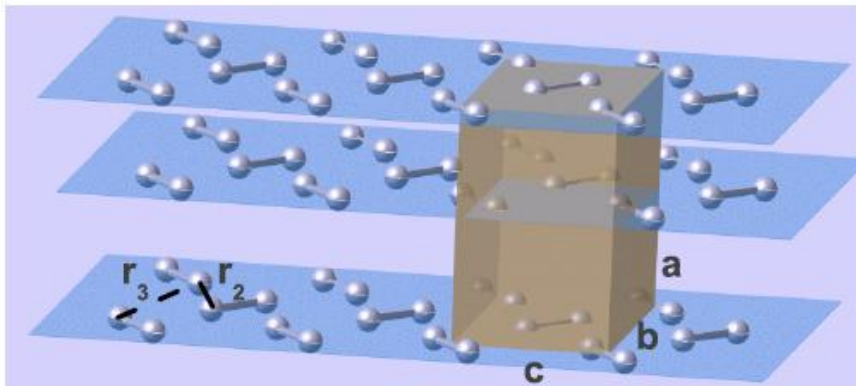

The heavier halogens (Br_2 , I_2) are model systems for the study of simple molecular solids under high pressure as the necessary pressures for metallization or dissociation are typically a factor of 10 to 100 smaller than for H_2

Hydrogen

- ◆ The most abundant element
- ◆ The only quantum molecular solids
- ◆ Insulator at ambient
- ◆ Implication for the understanding of the interior of giant planets, such as Jupiter, that is 90% hydrogen, most of which is at ultrahigh pressures in a fluid metallic state

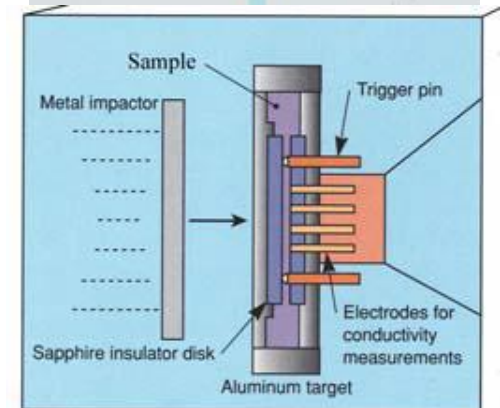
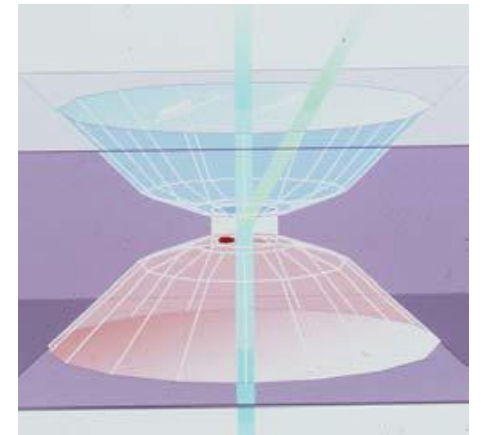

Insulator-to-metal: example 4

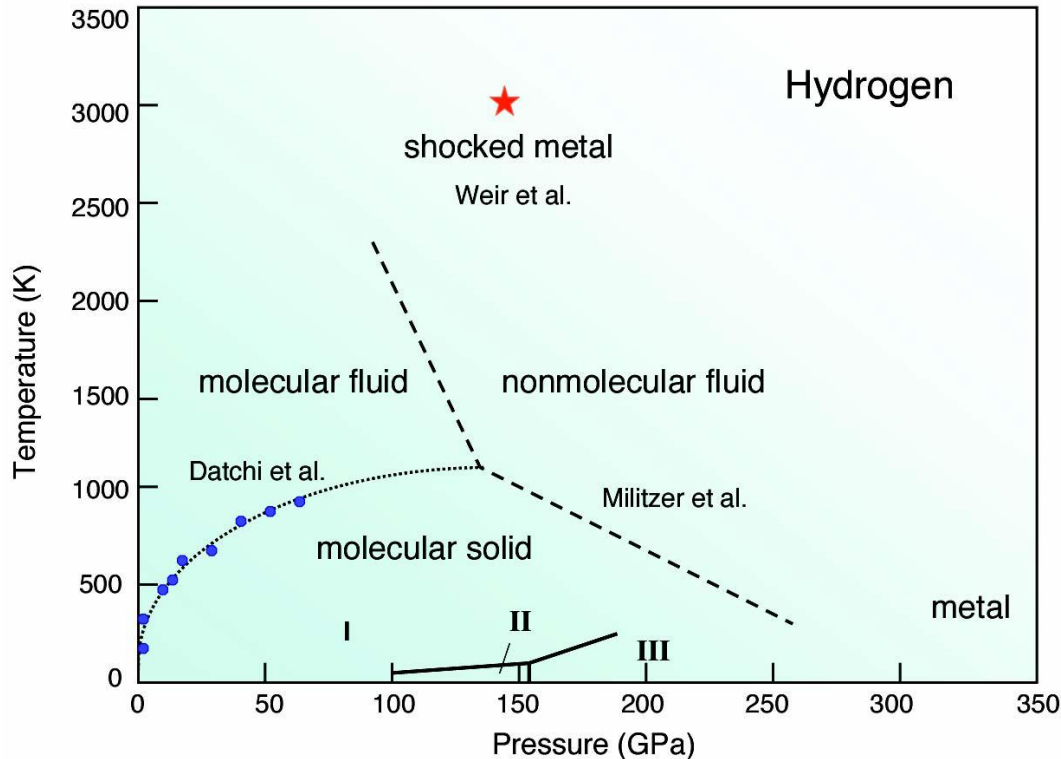

- ◆ Molecular state persists over a broad P-T range
- ◆ The evidence for a conducting fluid at pressures lower than previously thought extends considerably the previously assumed radial extent of the conducting region of Jupiter.
- ◆ The results can now further assist in understanding both the luminosity of the planet and the origin of its large magnetic field, which is generally believed to be associated with fluid metallic hydrogen within the planet's mantle.

Oxygen

- At pressures of around 100 GPa, solid oxygen becomes superconducting, with a transition temperature of 0.6 K. The transition is revealed by both resistivity measurements and a Meissner demagnetization signal
- Since solid oxygen above 96 GPa remains in the molecular state. Superconductivity of oxygen appears at the molecular metallic state.

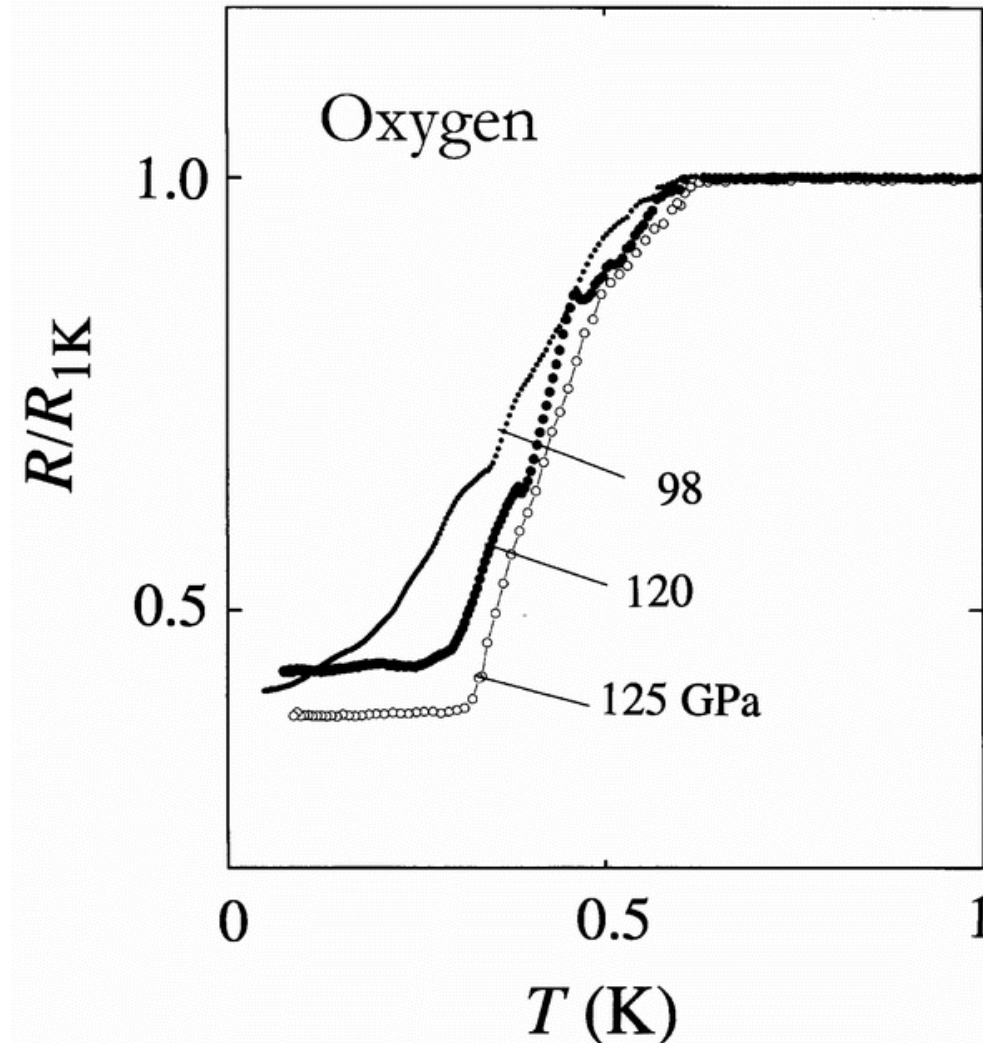

Sodium

- ◆ Intuitively, pressure produces an increase in the widths of the valence and conduction bands and hence a more pronounced free-electron-like behaviour



Sodium

- At 200 GPa (corresponding to approximately 5.0-fold compression), Na transforms into an optically transparent phase
- Experimental and computational data identify the new phase as a wide bandgap dielectric with a six-coordinated, highly distorted double-hexagonal close-packed structure
- The emergence of this dense insulating state is attributed to p-d hybridization of valence electrons and their repulsion by core electrons into the lattice interstices.
- Such insulating states may also form in other elements and compounds when compression is sufficiently strong that atomic cores start to overlap strongly.

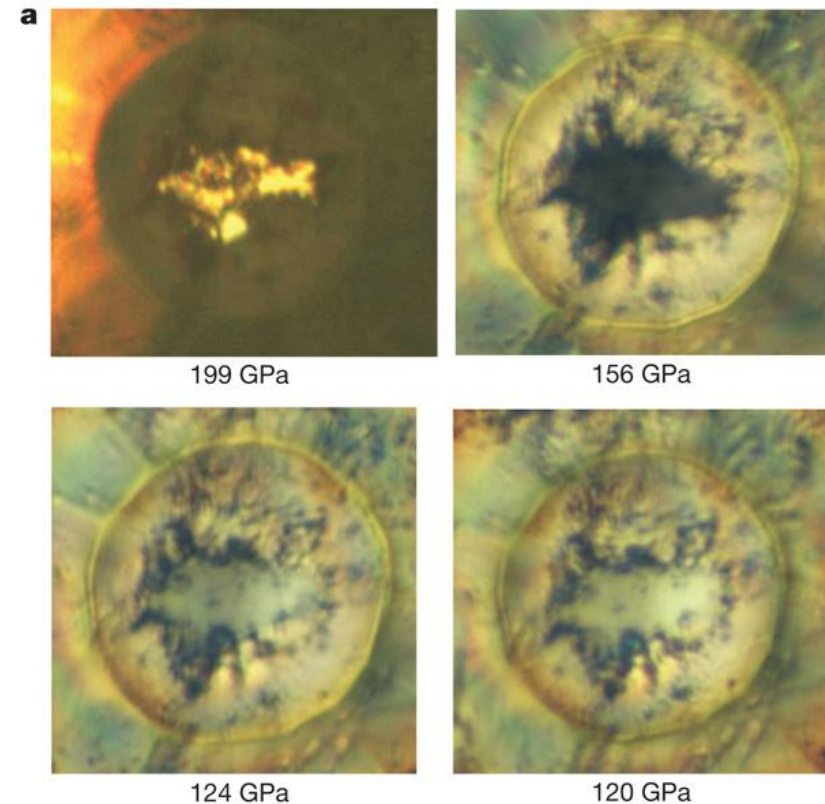

Collapse of ferromagnetism: iron

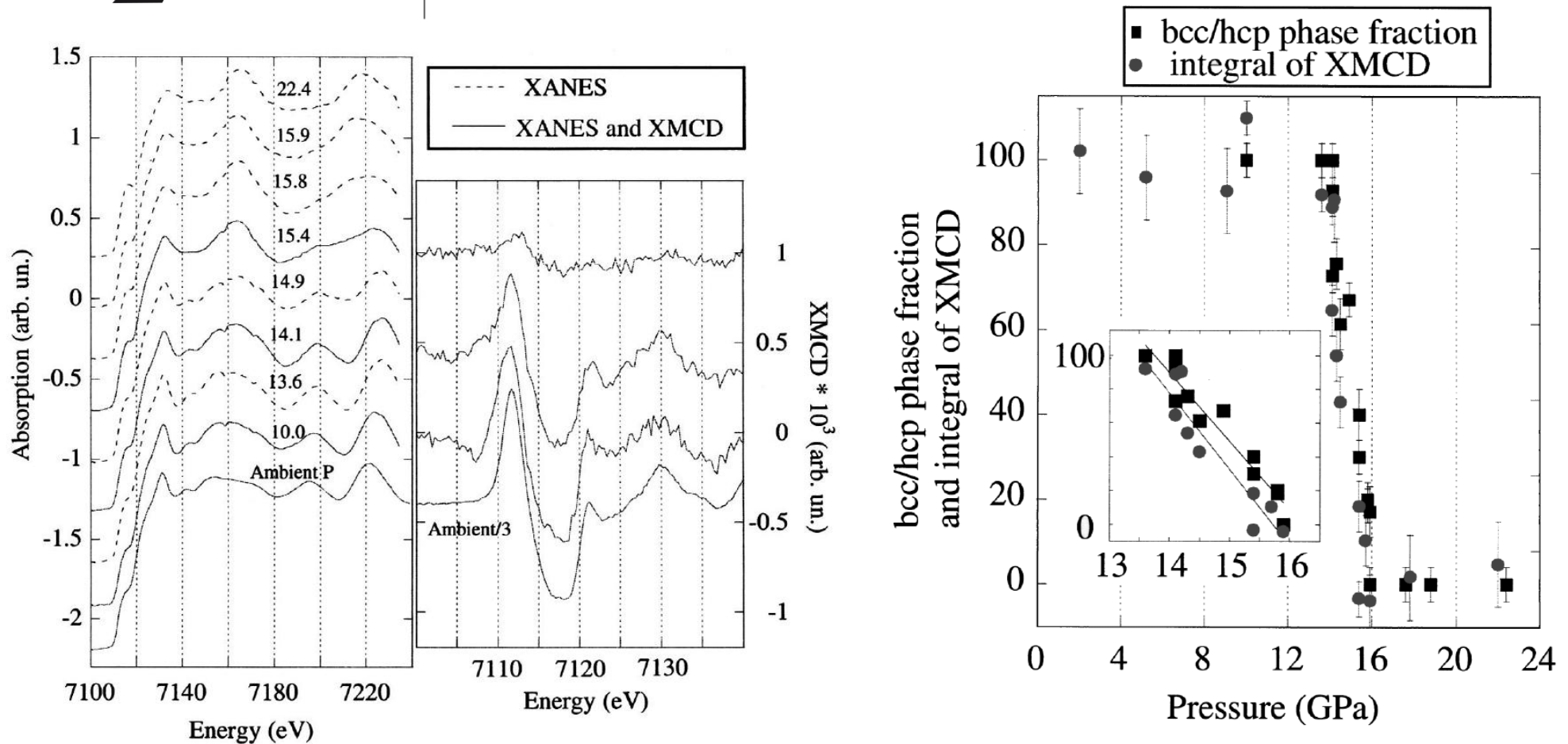

- ▶ FM bcc to non-FM hcp transition in the 13-16 GPa range
- ▶ The origin of the instability of the bcc phase can be attributed to the suppression of magnetism caused by pressure

Collapse of ferromagnetism: Co

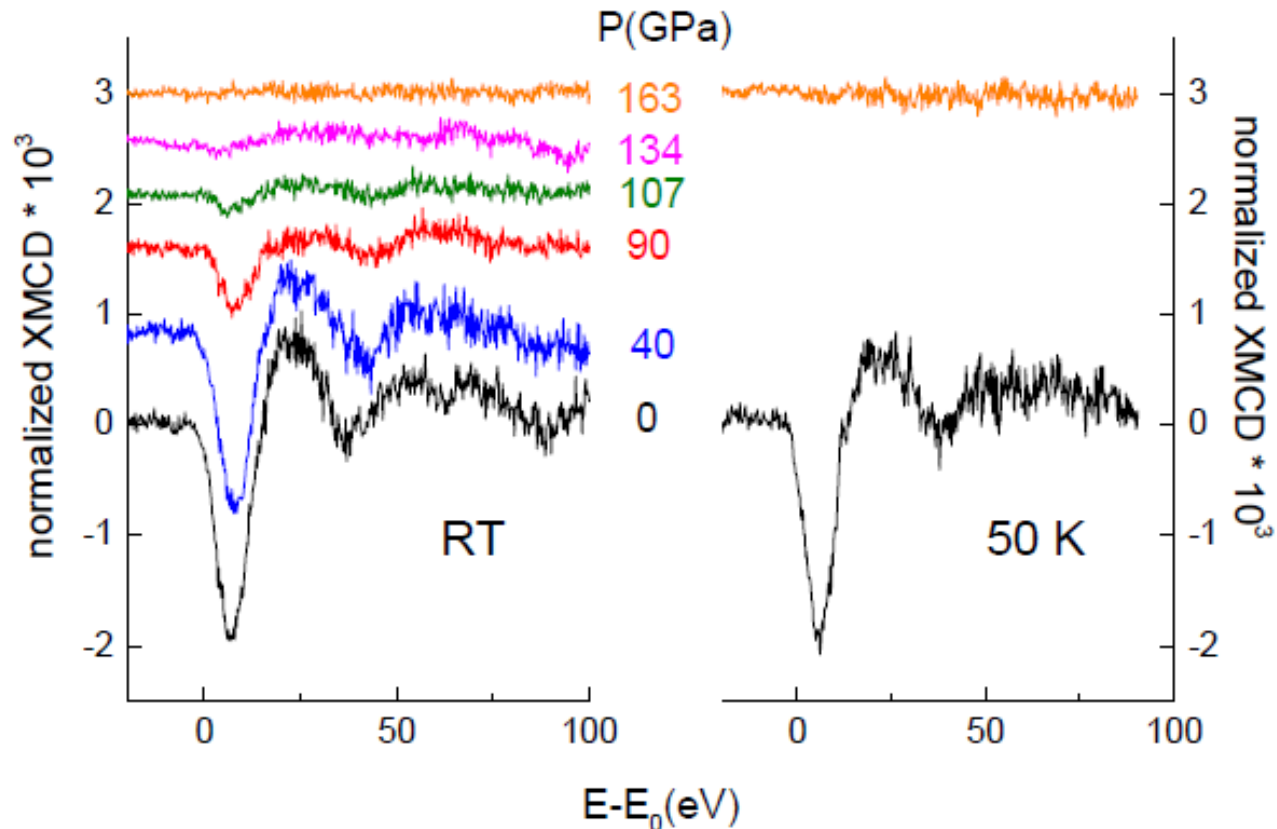

- ◆ FM is suppressed at $P > 130$ GPa in mixed hcp-fcc phase
- ◆ No re-appearance of the signal at low temperature (50 K), indicating that the high pressure state is likely non-magnetic

Collapse of the magnetism: Ni

- ◆ No structural changes are observed up to 200 GPa
- ◆ Fcc Ni is still FM at 200 GPa
- ◆ Comparisons with DFT calculations expects a collapse of FM above 400 GPa

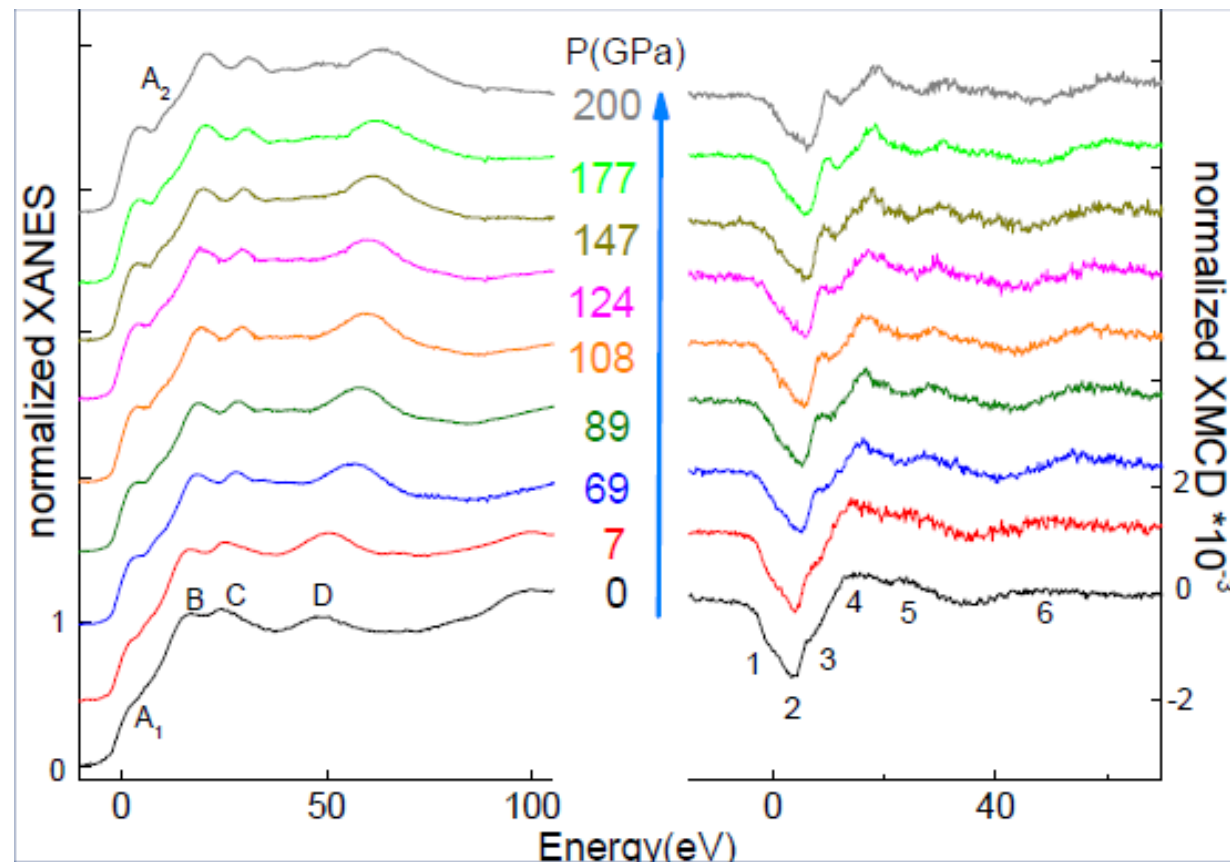

Collapse of ferromagnetism: summary

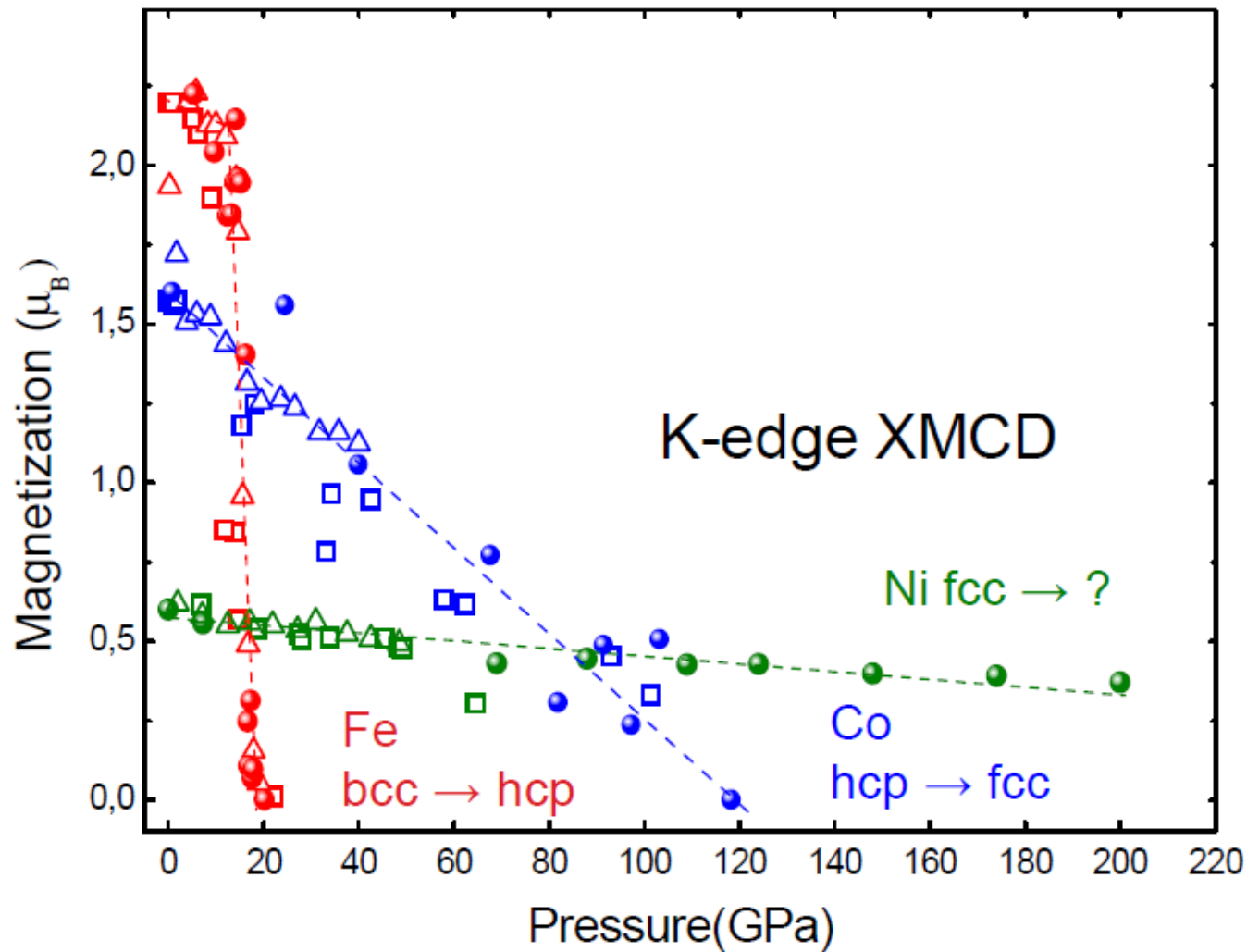

Loss of magnetism drives structural changes

Phase transitions to simpler structures

Arsenic

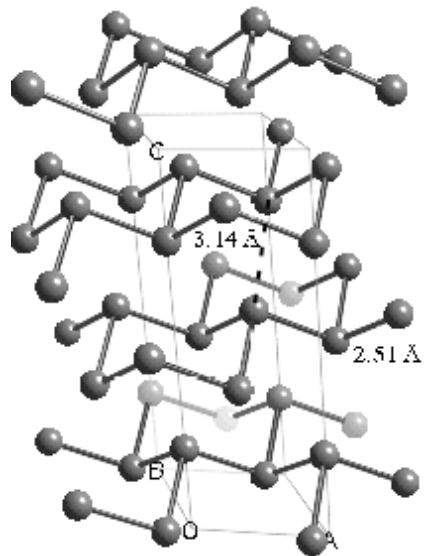

rhombohedral

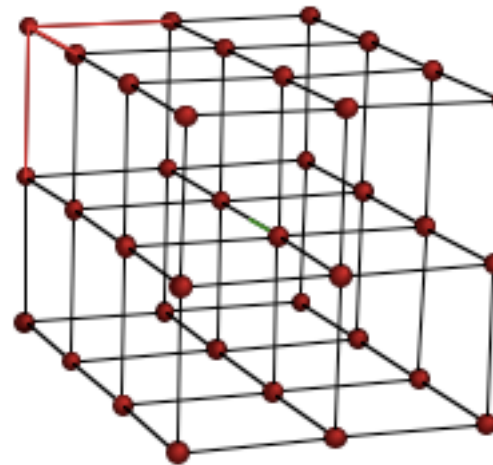
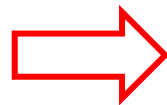

Simple cubic

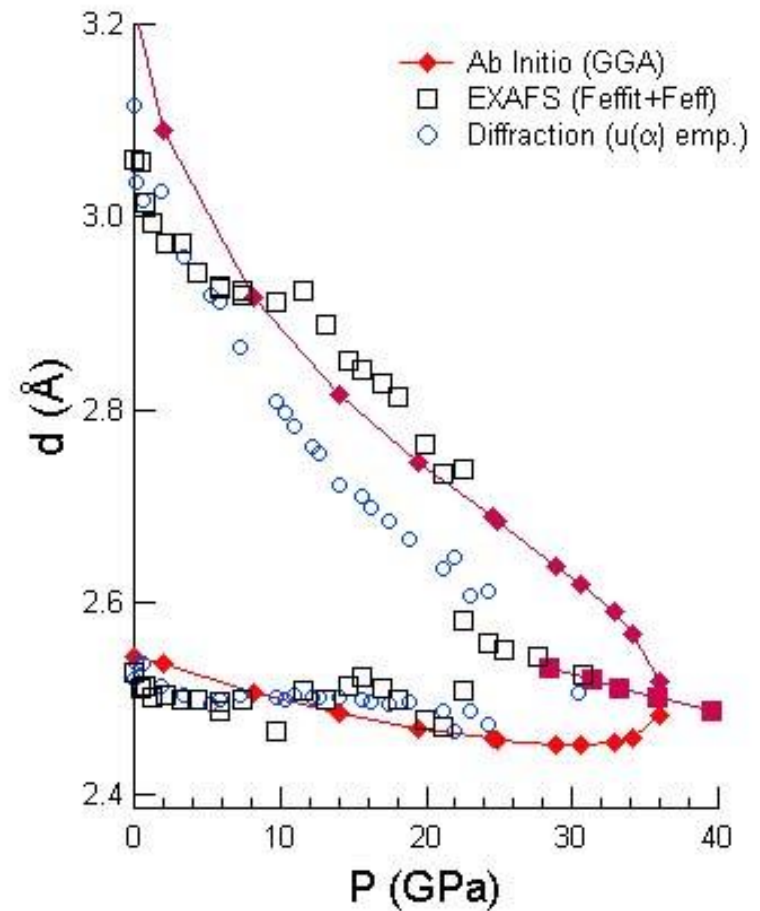

Europium: incommensurate to incommensurate phase transitions

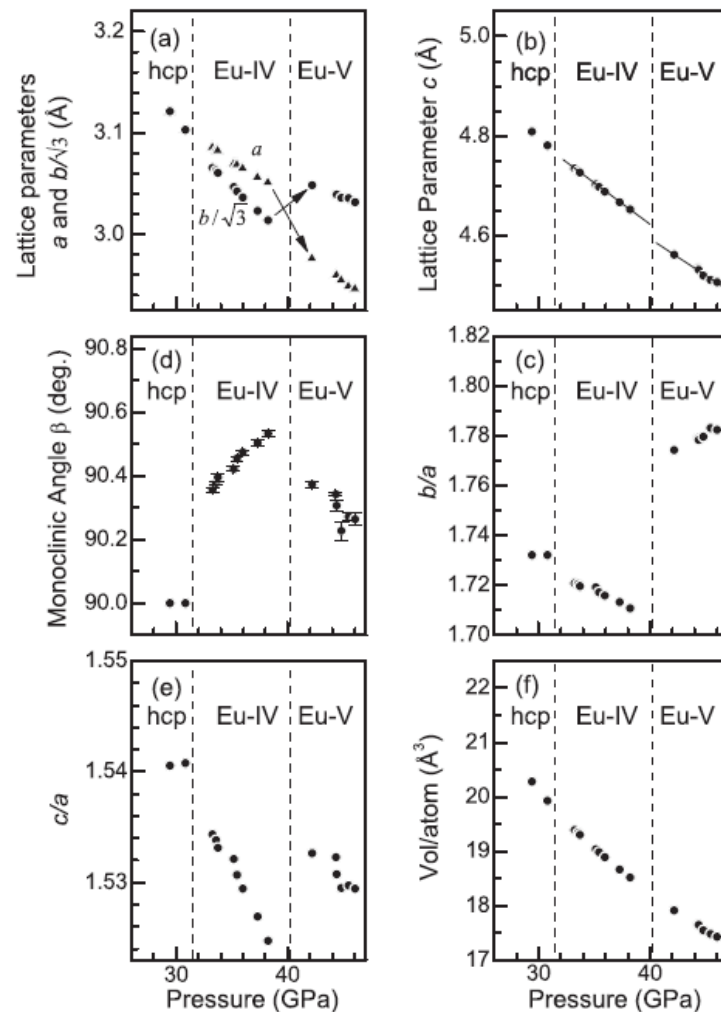
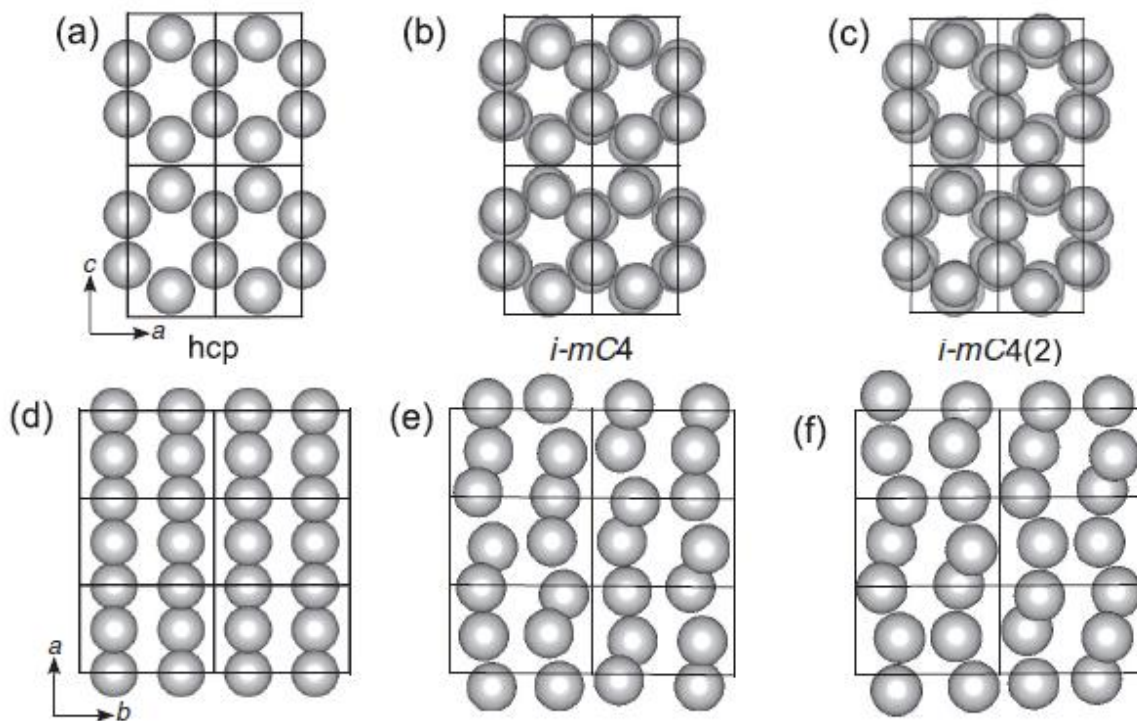

Osmium to 770 GPa

- At ambient, Os has the highest density, one of the highest cohesive energies and melting temperatures. Very incompressible
- Os retains its hexagonal close-packed structure upon compression to over 770 GPa

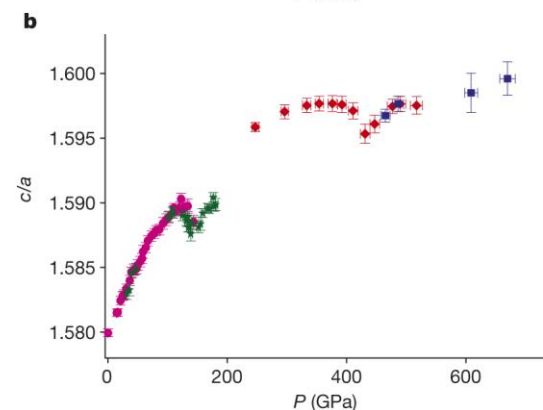
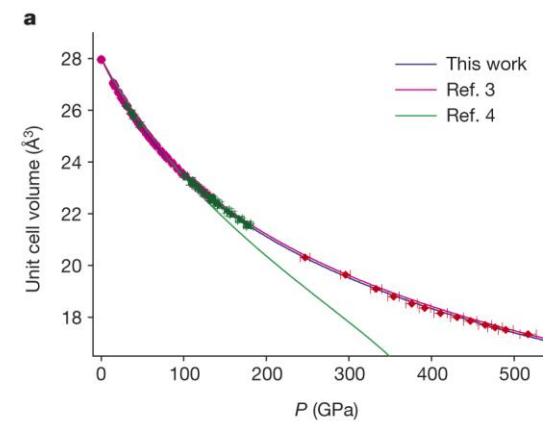
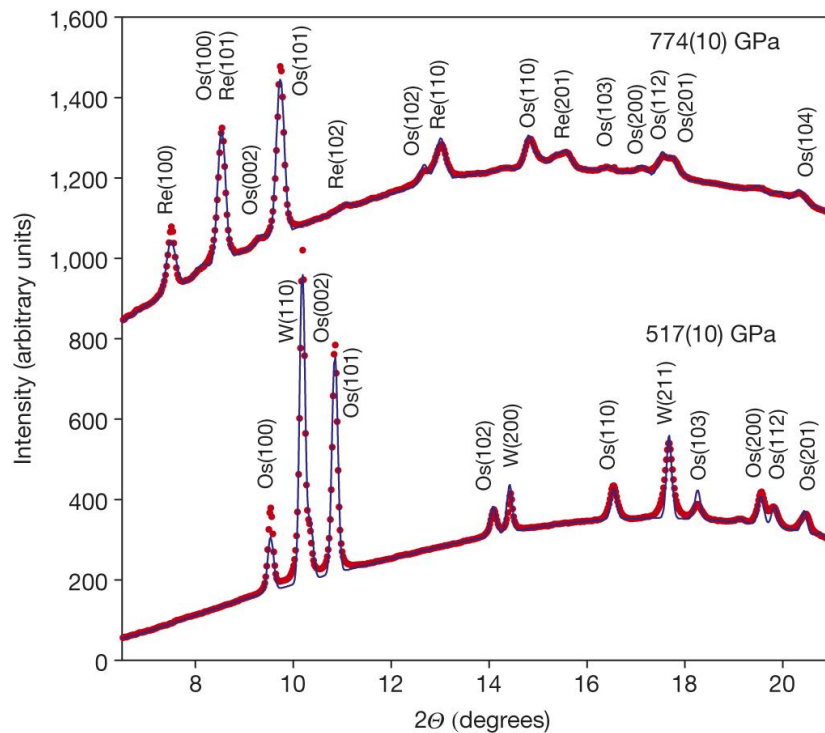



- ◆ Introduction
- ◆ Effects of pressure
 - ◆ Insulator to metal transitions
 - ◆ Metal to insulator transitions
 - ◆ Effects on magnetism
 - ◆ Structural phase transitions
- ◆ High pressure and Earth's science
- ◆ Tools and methods
- ◆ Examples of high pressure research using XAS
 - ◆ Polyamorphism in glassy GeO_2
 - ◆ Melting of iron at megabar pressures
 - ◆ Revealing Earth's interior
- ◆ Bibliography

$10^3 \text{ atm} = \text{kbar}$
 $10^6 \text{ atm} = \text{Mbar}$
 $10 \text{ kbar} = 1 \text{ GPa}$
 $1 \text{ Mbar} = 100 \text{ GPa}$

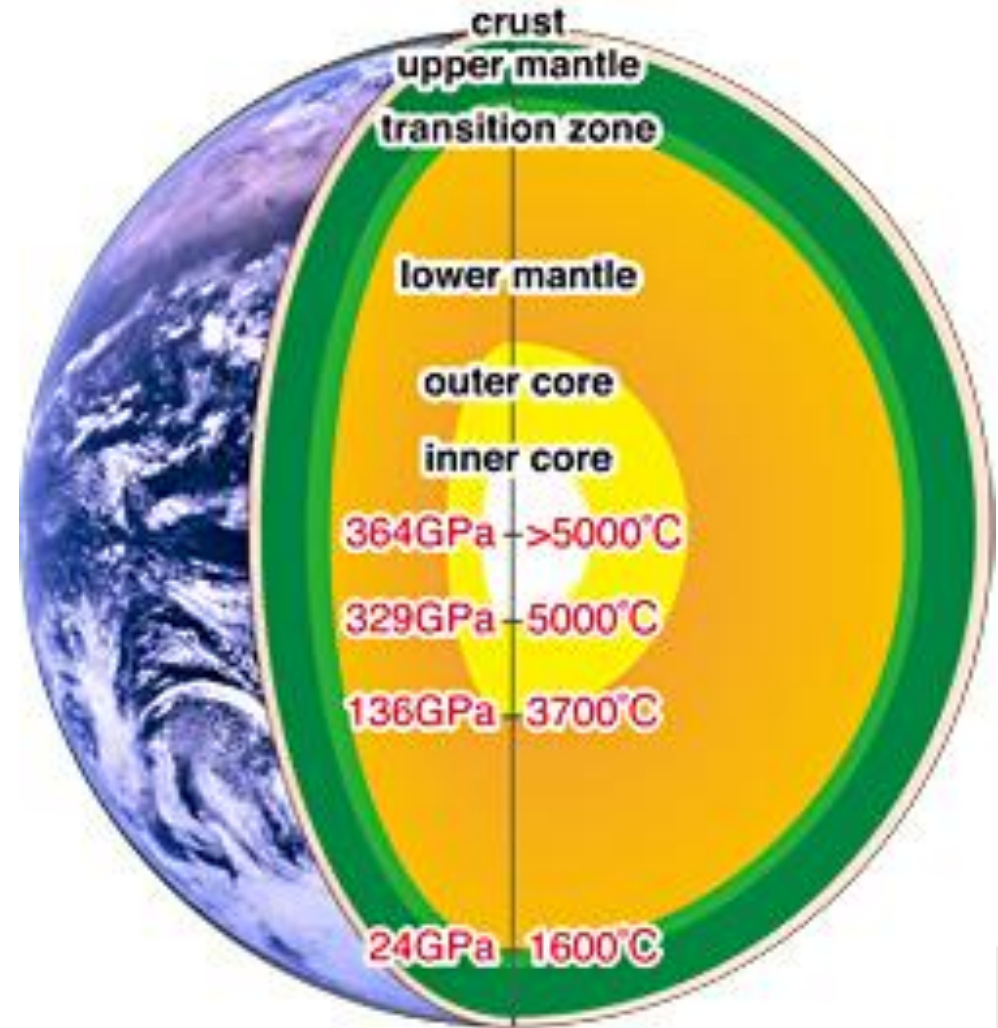

Earthquakes and volcanic eruptions result from chemical reactions and motions in Earth's mantle, the stony region from a few tens of km depth beneath the continents to almost 3000 km in depth.



Buried at shallow levels beneath the ocean floor and preserved by high pressures in the sediments are the greatest known deposits of hydrocarbon energy resources.

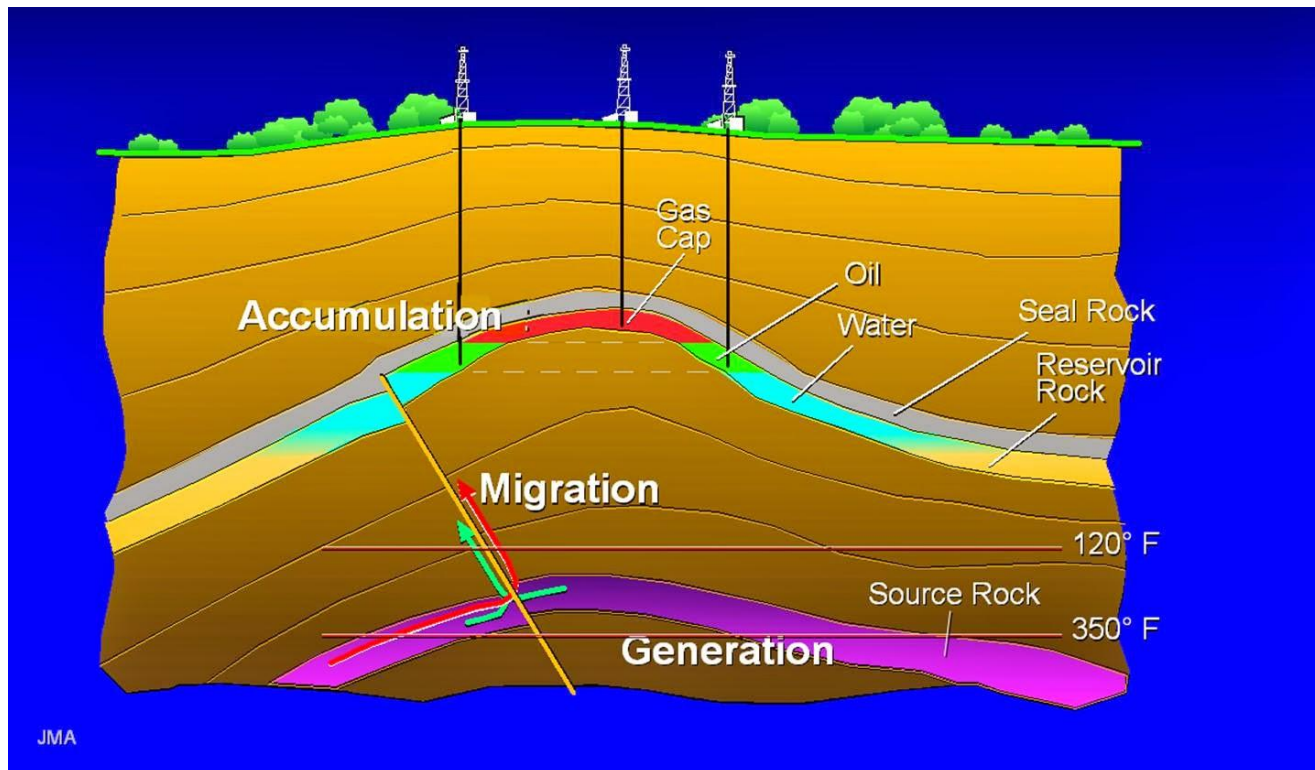

At the mantle

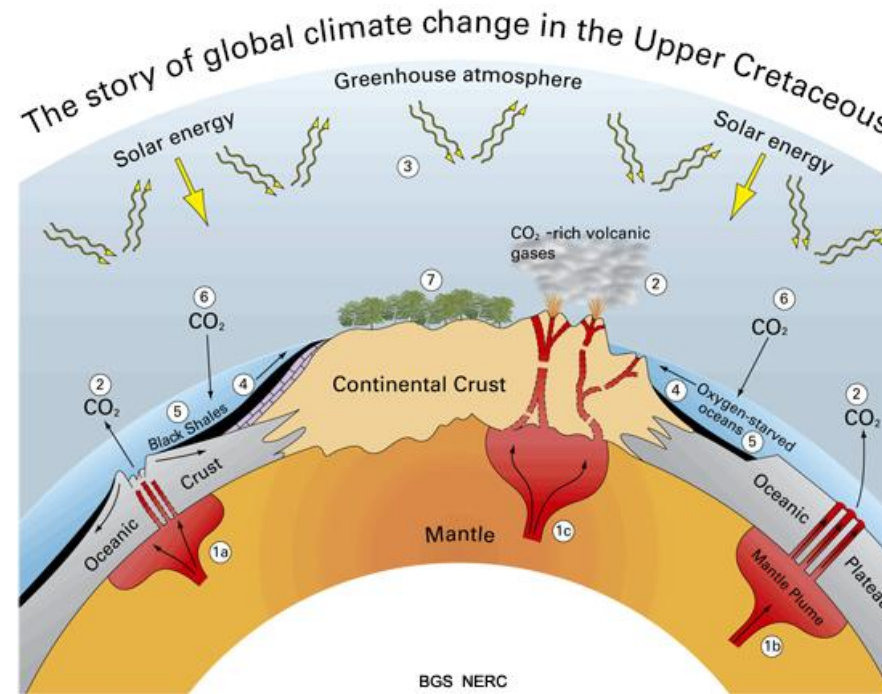

- ◆ Earth's mantle likely contains far more water and carbon dioxide than is present in all the world's oceans and atmosphere combined
- ◆ Mantle processes have probably had a strong influence on the quantity of carbon dioxide - a major greenhouse gas - present in the atmosphere

Direct evidence of carbon reservoirs in the mantle can be seen in diamonds

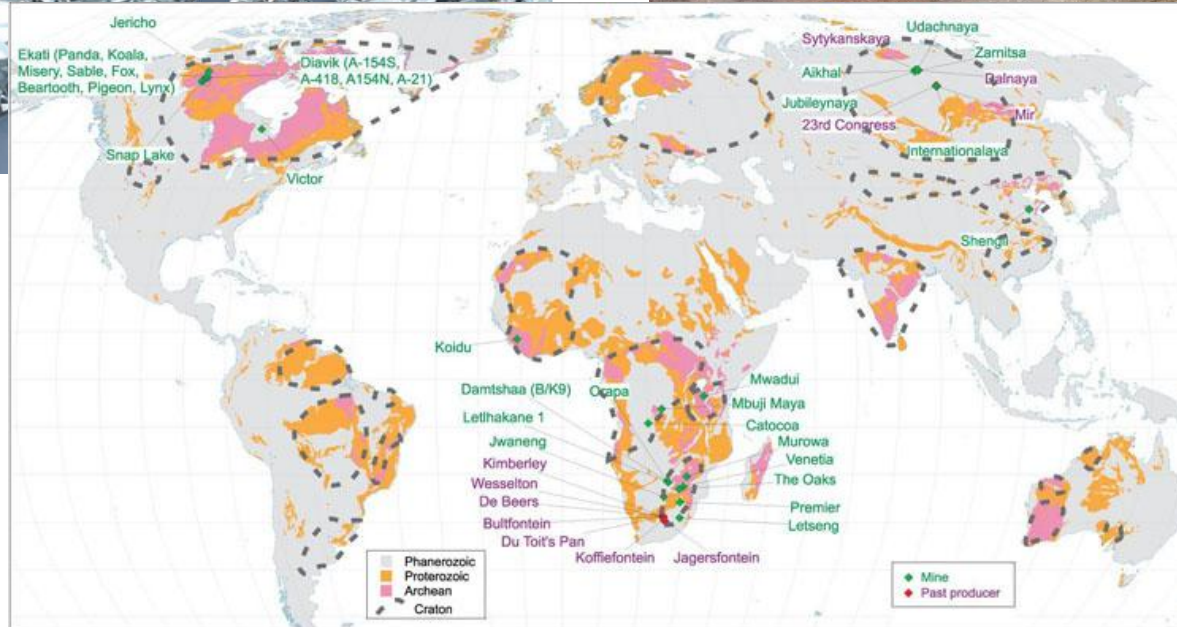
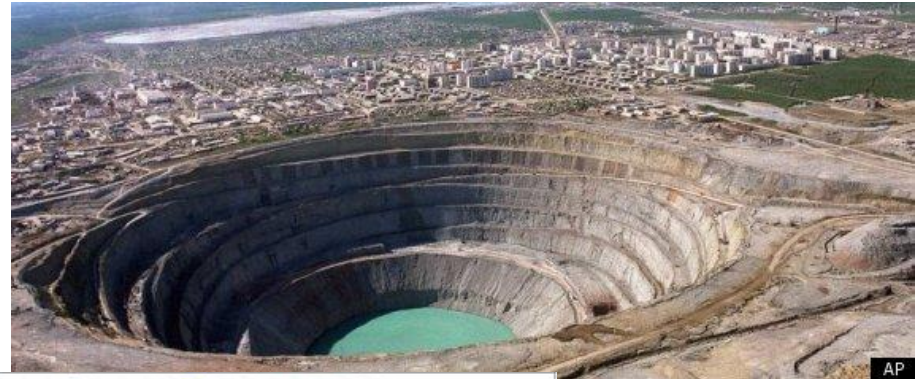
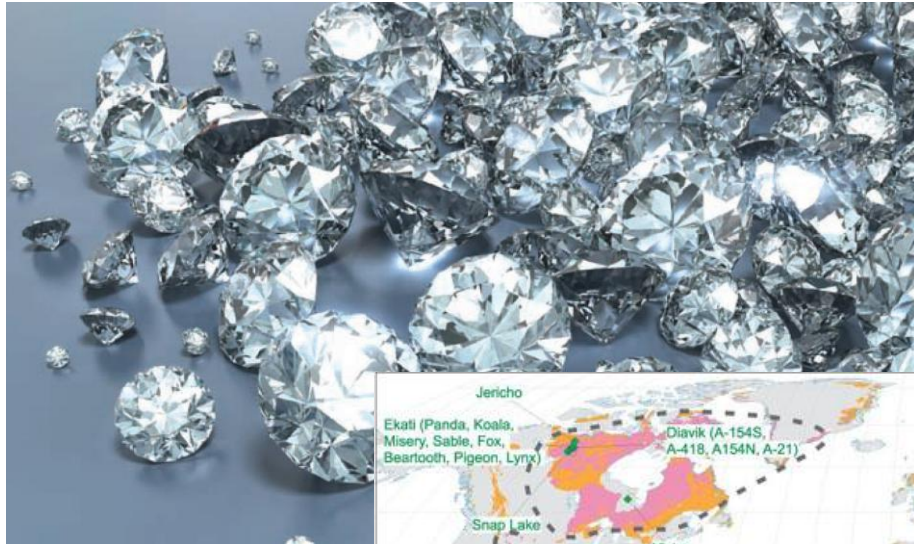

Global distribution of kimberlite hosted diamond mines and major Archean cratons.

Source: Geological Survey of Canada

- ❖ No borehole has ever pierced Earth's thin crust due to the high temperatures and pressures existing at depth
- ❖ Our information about the Earth's interior came from study of Earthquake shock waves, complemented by cosmochemistry and mineral physics



Volcanoes bring materials to the surface from depths of ~ 100 km

Diamonds may come from ~ 400 km

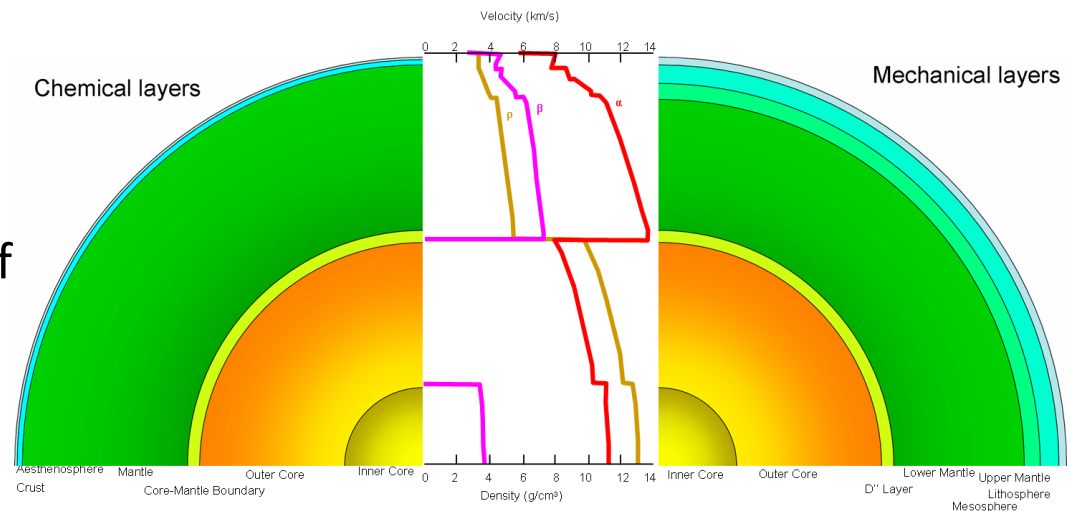

By studying how long it takes waves to pass through Earth (travel times) we worked out a model for the internal structure of the planet

- ◆ The last two decades have brought unprecedented advances in understanding Earth's interior as well as other planetary bodies in our solar system and beyond
- ◆ The simple layered models depicted in textbook diagrams are being replaced with more sophisticated models that show the complexity and dynamics of Earth's interior

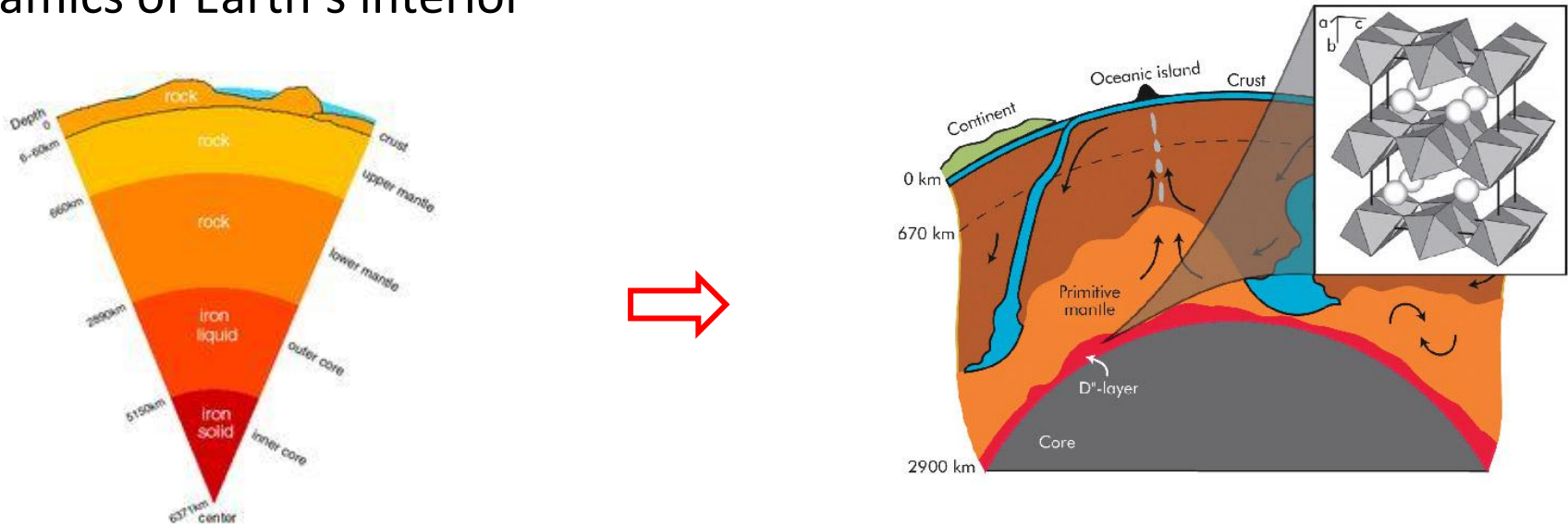

- ◆ The features of this internal system give us clues as to how the interior works – for example how material moves, how heat is transported and what it is made of – and how Earth developed to this state.

We now know that motions in Earth's metallic core are responsible for the magnetic field at the surface

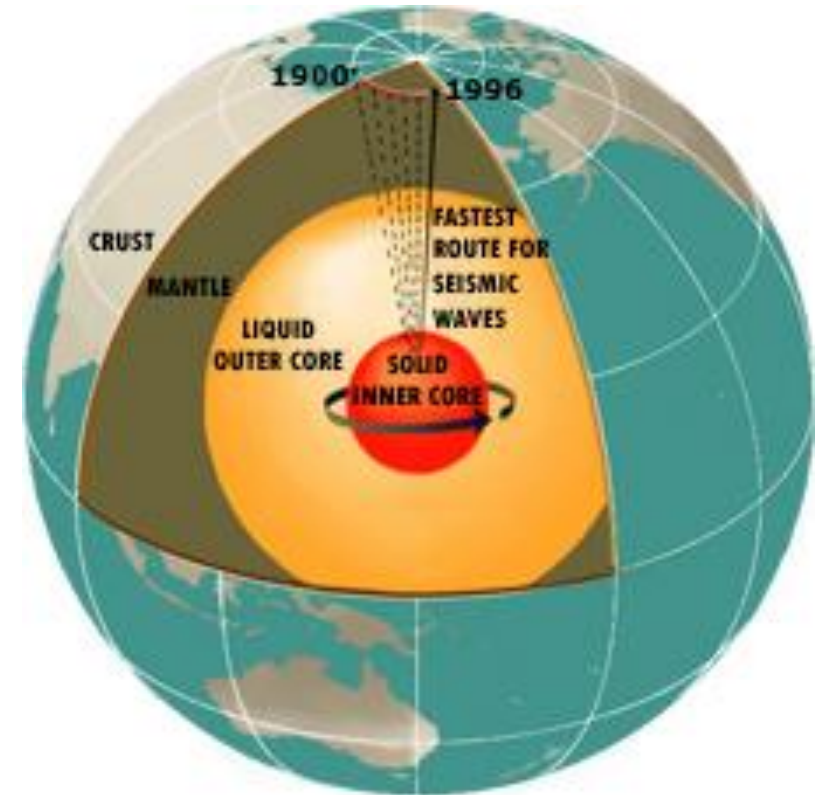
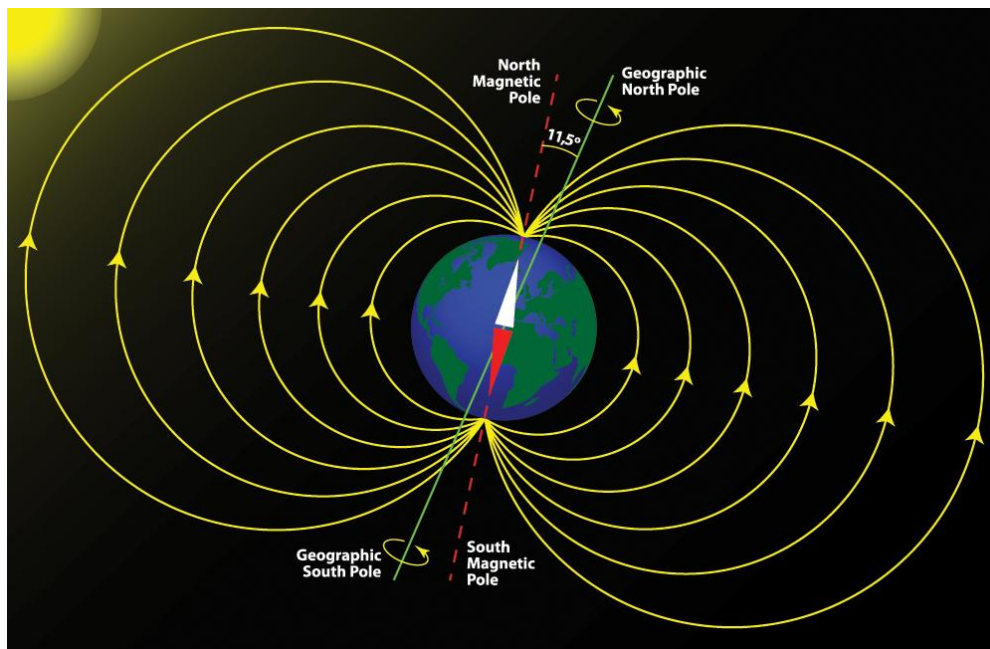

Computer simulations show liquid metal flow in the outer core can generate a magnetic field like Earth's

- ❖ One of the greatest achievements of high pressure science has been the ability to reach pressures and temperatures of Earth's core in the laboratory
- ❖ This pressure regime is from 130 GPa at the boundary between the rocky mantle and the liquid core (or Core Mantle Boundary - CMB) to 360 GPa at Earth's center
- ❖ Today not only it is possible to reach these pressures, but samples can be heated to core temperatures (~ 6000 K) using focused laser beams, while probing the atomic, electronic and magnetic structures using XRD, XAS and other SR-based techniques
- ❖ Sophisticated quantum mechanical calculations can be performed to simulate the behavior of minerals and iron at the relevant P and T conditions.

- ◆ Any realistic interpretation of the geophysical observations requires accurate knowledge of the properties of candidate materials under extremely high pressures and temperatures
- ◆ For example, to understand the cause of seismic anisotropy of the inner core and how core material deforms in response to various forces, we need to know the elastic constants of iron under inner core conditions

Elastic constant using Inelastic x-ray scattering



Contents lists available at ScienceDirect

Earth and Planetary Science Letters

journal homepage: www.elsevier.com/locate/epsl



Composition of the Earth's inner core from high-pressure sound velocity measurements in Fe–Ni–Si alloys

Daniele Antonangeli^{a,b,*}, Julien Siebert^{a,b}, James Badro^{a,b}, Daniel L. Farber^{b,c}, Guillaume Fiquet^a, Guillaume Morard^a, Frederick J. Ryerson^b

^a Institut de Minéralogie et de Physique des Milieux Condensés, UMR CNRS 7590, Institut de Physique du Globe de Paris, Université Pierre et Marie Curie, Université Paris Diderot, 75005 Paris, France

^b Lawrence Livermore National Laboratory, Livermore, CA 94550, USA

^c Department of Earth and Planetary Sciences, University of California, Santa Cruz, Santa Cruz, CA, 95064, USA

A B S T R A C T

We performed room-temperature sound velocity and density measurements on a polycrystalline alloy, $\text{Fe}_{0.89}\text{Ni}_{0.04}\text{Si}_{0.07}$, in the hexagonal close-packed (hcp) phase up to 108 GPa. Over the investigated pressure range the aggregate compressional sound velocity is $\sim 9\%$ higher than in pure iron at the same density. The measured aggregate compressional (V_P) and shear (V_S) sound velocities, extrapolated to core densities and corrected for anharmonic temperature effects, are compared with seismic profiles. Our results provide constraints on the silicon abundance in the core, suggesting a model that simultaneously matches the primary seismic observables, density, P-wave and S-wave velocities, for an inner core containing 4 to 5 wt.% of Ni and 1 to 2 wt.% of Si.

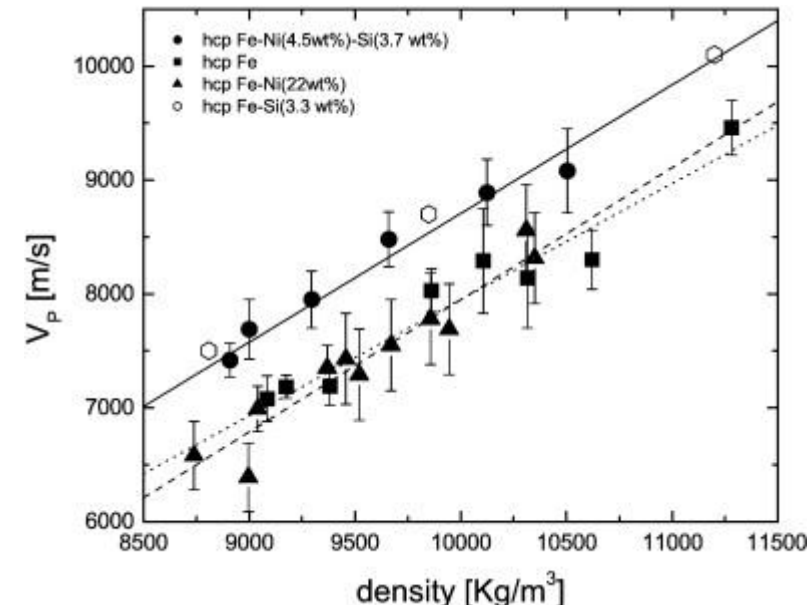



- ◆ Introduction
- ◆ Effects of pressure
 - ◆ Insulator to metal transitions
 - ◆ Metal to insulator transitions
 - ◆ Effects on magnetism
 - ◆ Structural phase transitions
- ◆ High pressure and Earth's science
- ◆ **Tools and methods**
- ◆ Examples of high pressure research using XAS
 - ◆ Polyamorphism in glassy GeO₂
 - ◆ Melting of iron at megabar pressures
 - ◆ Revealing Earth's interior
- ◆ Bibliography

- ◆ Large volume press
 - ◆ Large sample volume ($\text{mm}^3 - \text{cm}^3$)
 - ◆ Bulky facilities (many tons)
 - ◆ P max ~ 60 GPa
 - ◆ T max ~ 2000 K

- ◆ Paris- Edinburgh press
 - ◆ Large sample volume (mm^3)
 - ◆ Relatively compact ~ 100 kg
 - ◆ P max ~ 30 GPa
 - ◆ T max ~ 2000 K

- ◆ Diamond Anvil Cell
 - ◆ Small sample volume ($< 10^{-4} \text{mm}^3$)
 - ◆ Compact $< 1\text{kg}$
 - ◆ P max ~ 800 GPa
 - ◆ T max ~ 6000 K



Large volume press



crichton@esrf.fr

Id06 - ESRF
2000 Tonnes force
20 GPa, 2000 K

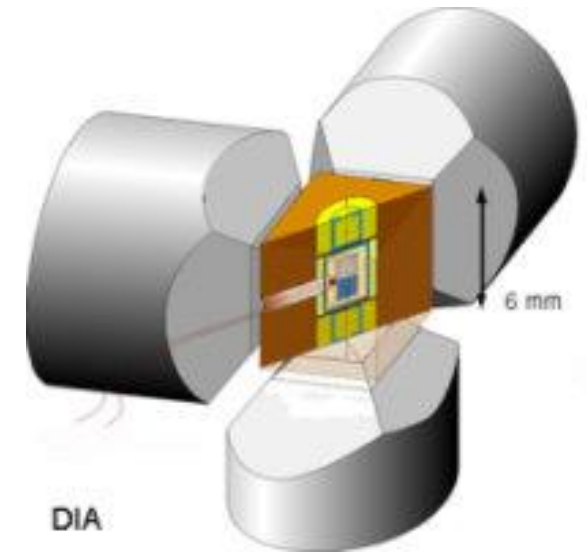

DIA

DIA module

The cubic setup
compressed between
6 anvils

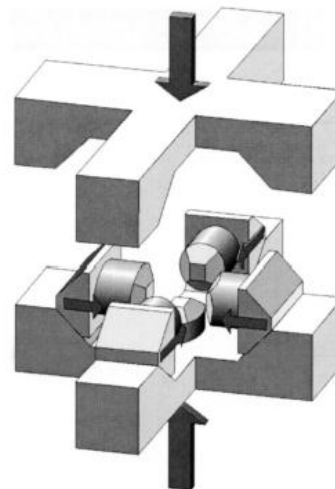
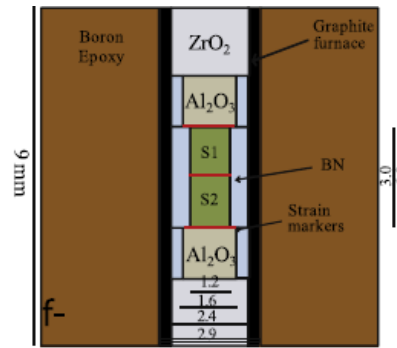

D-DIA

Top and bottom anvils can be
moved independently
allows deformation
experiments to be performed
under upper mantle P-T conditions



Paris-Edinburgh press

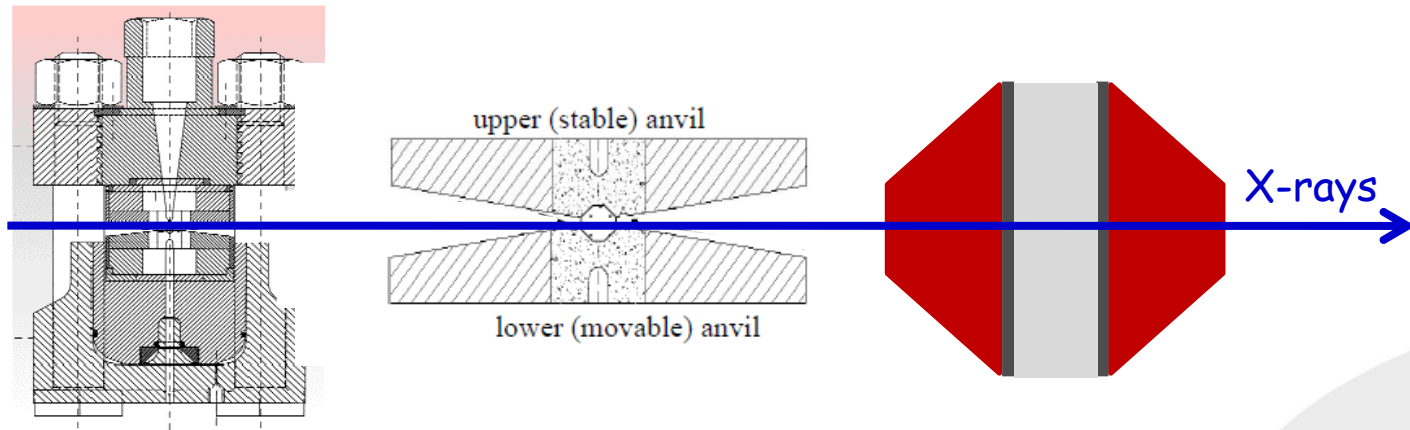
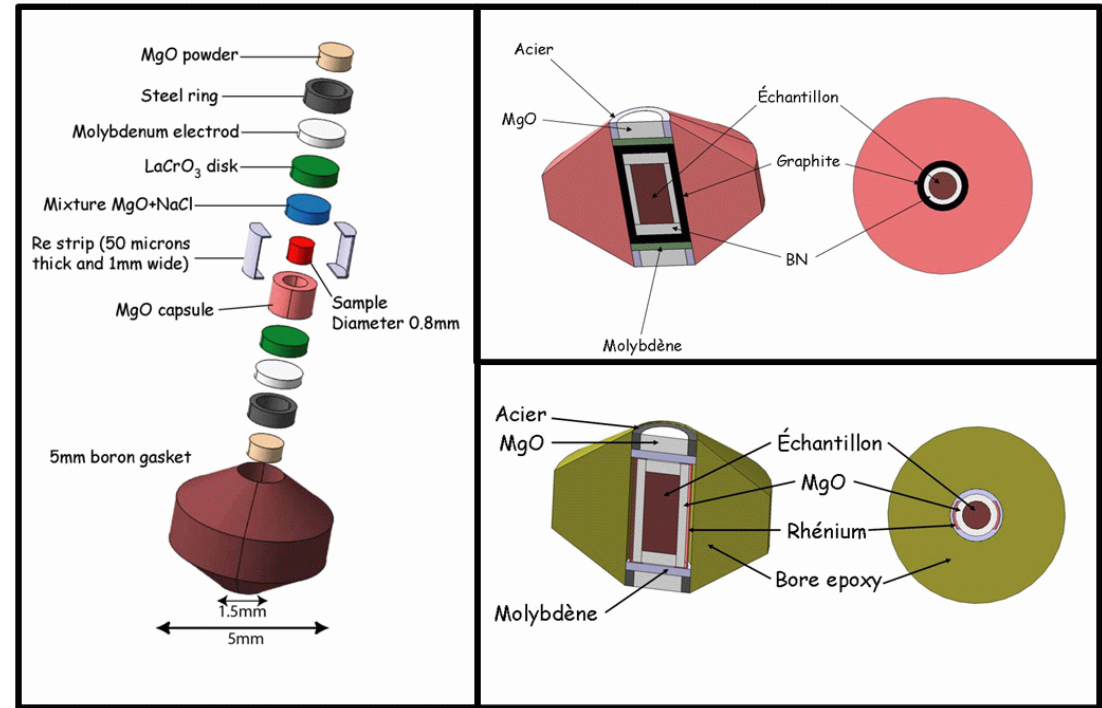

- ◆ The DAC allows to reach the highest static pressures
 - ◆ The first DAC was designed and constructed at the National Bureau of Standard (1959)
 - ◆ DAC can fit into the palm of the hand and can generate pressures above 700 GPa
-
- ◆ 100 GPa in 1976
 - ◆ 200 GPa in 1985
 - ◆ 300 GPa in 1990
 - ◆ 400 GPa in 2007
 - ◆ 640 GPa in 2012
 - ◆ 770 GPa in 2015

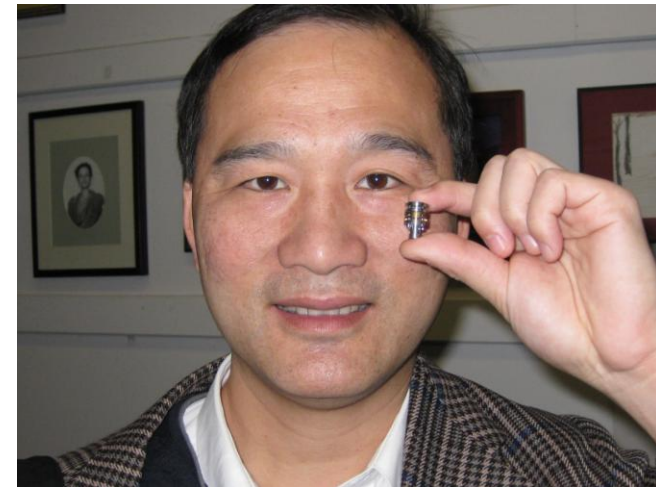

Two gem-quality single crystal (now also polycrystalline) diamonds with flat surfaces serve as anvil faces

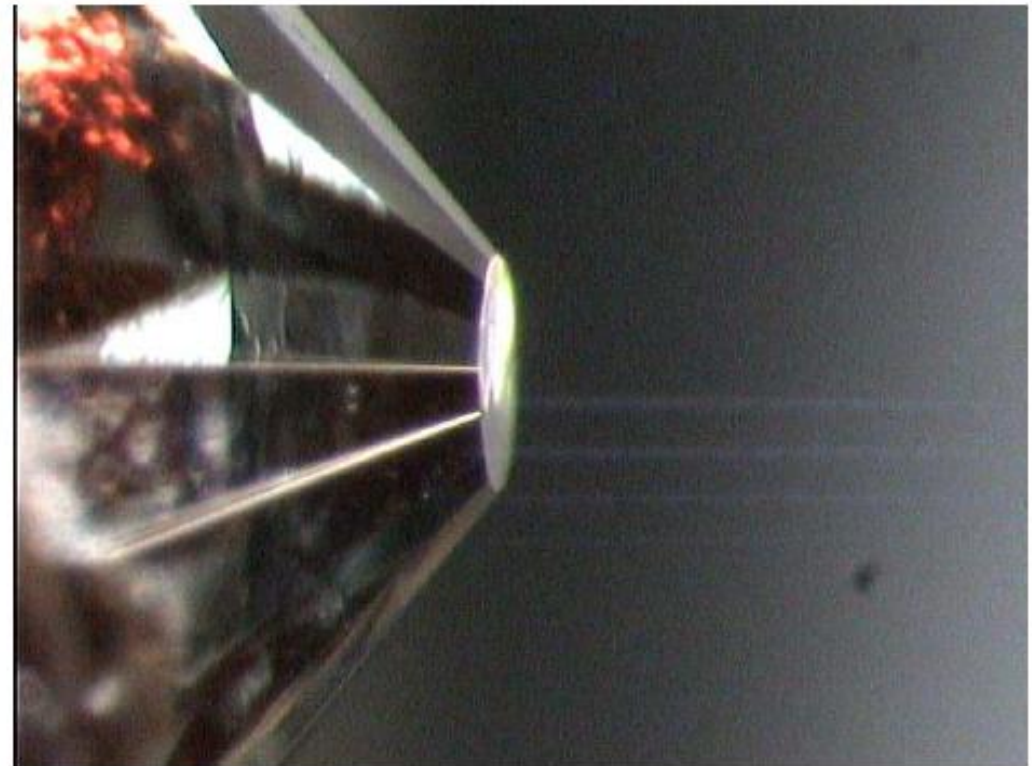
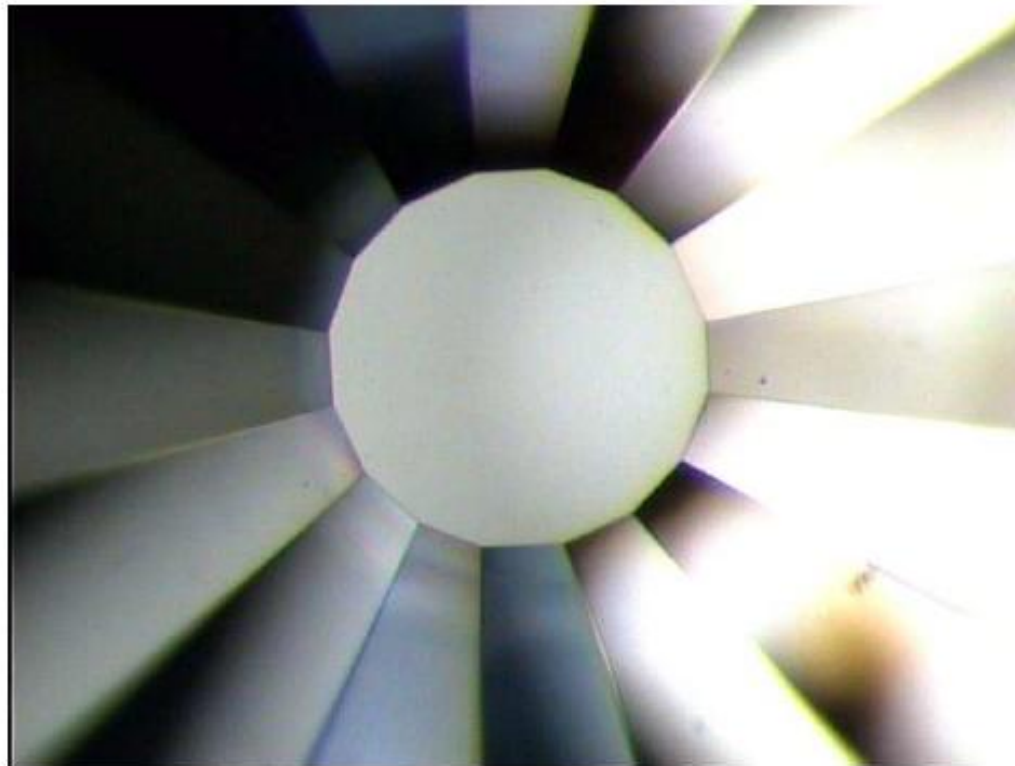

DAC: the principle

The diamonds are mounted so that the sample can be squeezed between the anvil faces



The smaller the area A of the of the anvil faces, the higher the pressure P reached by the DAC for an equivalent value of applied force F , according to –

P_{max} (GPa)	\varnothing flat (μm)
30	600
60	300
100	150

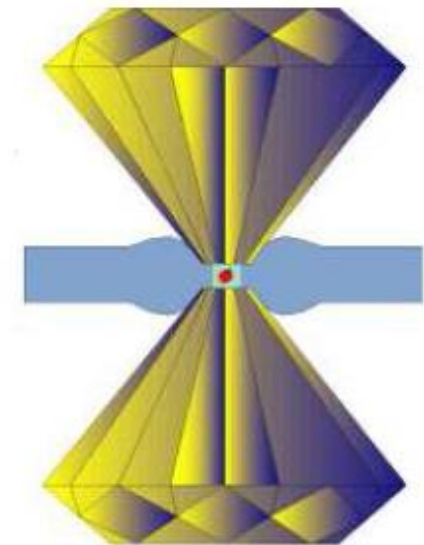

DAC: the pressure

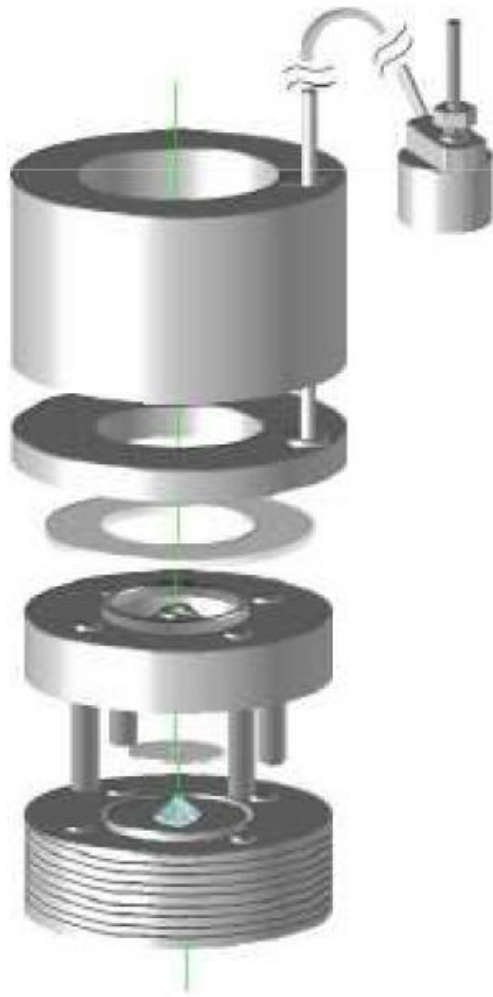

- ◆ To apply pressure, the anvils must have a high degree of parallelism.
- ◆ One of the diamond anvils is usually mounted on the end of a sliding piston, while the other is stationary
- ◆ A cylinder guides the piston so that the anvil faces meet very precisely
- ◆ The piston is pushed by a mechanical device such as a screw or a small hydraulic ram, thus driving the two anvils together

The adjustment procedure is made under microscope

The concentricity is achieved moving the support of the piston diamond slightly to superimpose the two polygons corresponding to the faces of the anvils

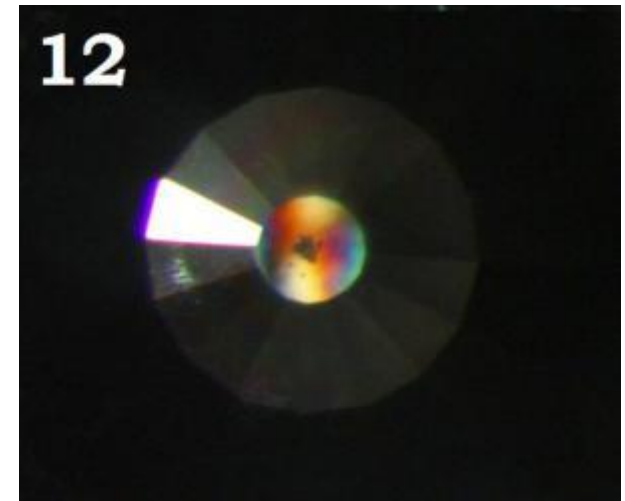
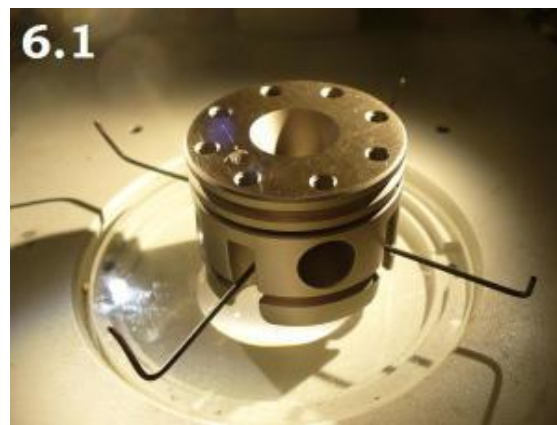
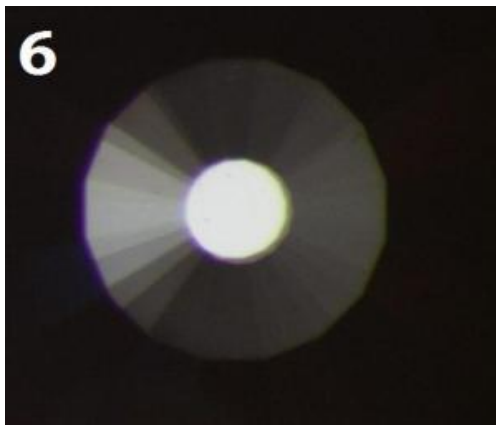

The parallelism is checked by observing the interference fringes that appear when the two anvils are not parallel

DAC: different models

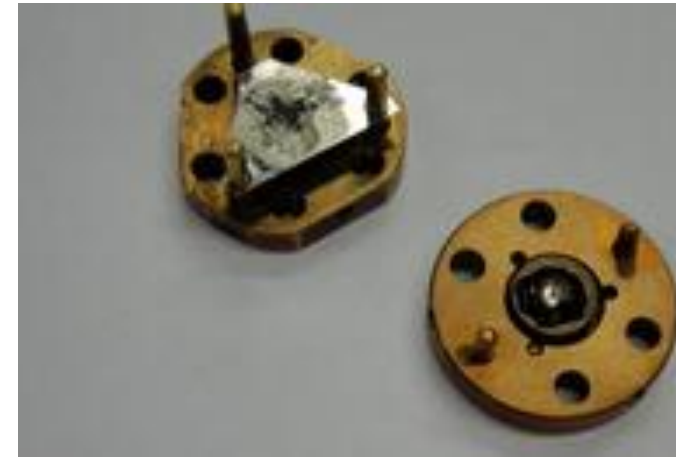

Double-stage diamond anvil cell

- ◆ Micro-anvils of 10 to 20 μm in diameter made of nanocrystalline diamonds
- ◆ These nanocrystals, which are diamond grains of a nano-size, are bound together forming a bulk micro-anvil
- ◆ The many grain boundaries make the nanocrystalline anvils even harder than single crystal diamonds, extending the range of static pressure in experiments from about 400 GPa to 770 GPa at room temperature

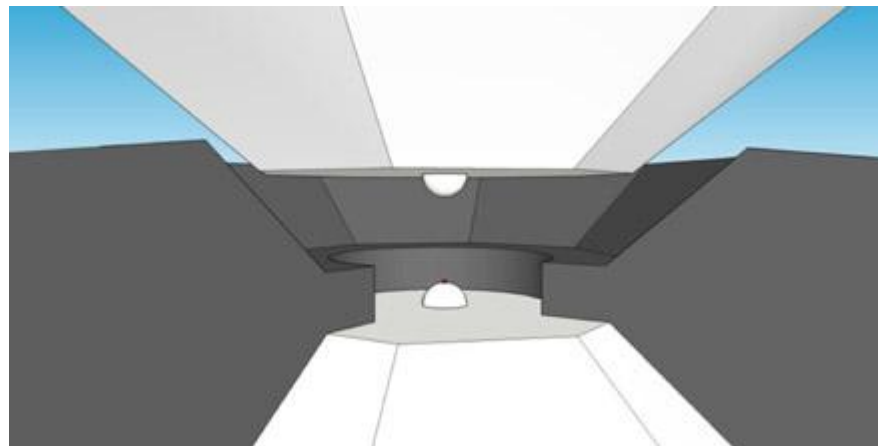

- ◆ When the sample is placed between the anvil faces, as the anvils are forced together, the sample is trapped and develops a uniaxial pressure, whose distribution ranges from a maximum at the center to essentially zero pressure at the edge of the sample area
- ◆ In order to have an isotropic pressure distribution the sample must be embedded and confined in a pressure transmitting medium softer than the sample.
- ◆ To encapsulate the sample and the hydrostatic medium, both are placed in a small hole drilled in a metallic gasket

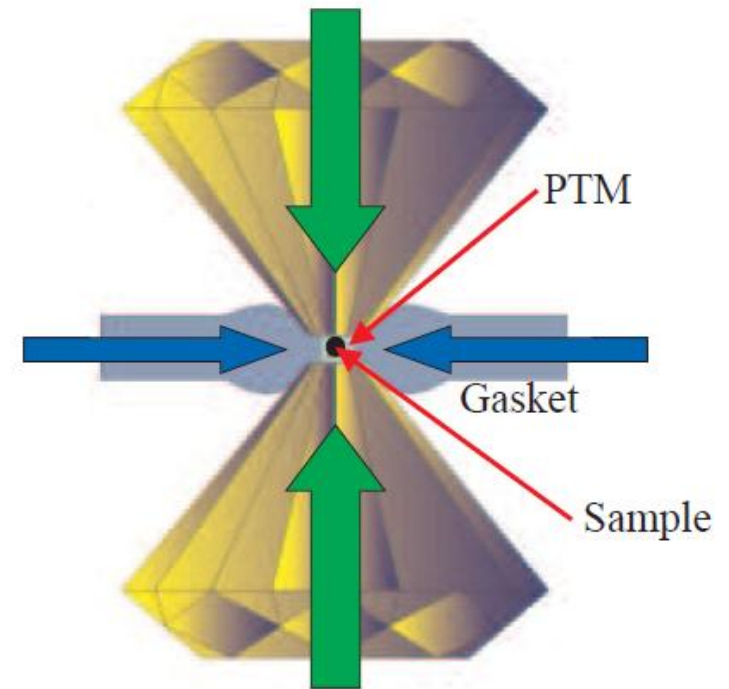

- ◆ The gasket consists of a metallic foil of typically 200 μm of thickness
- ◆ To increase the hardness of the metal, the foil placed between the two diamonds and is indented to about 30-60 μm .
- ◆ The higher the pressure that has to be achieved during the experiment, the higher the pre-indentation pressure and the smaller the final gasket thickness (and sample volume)

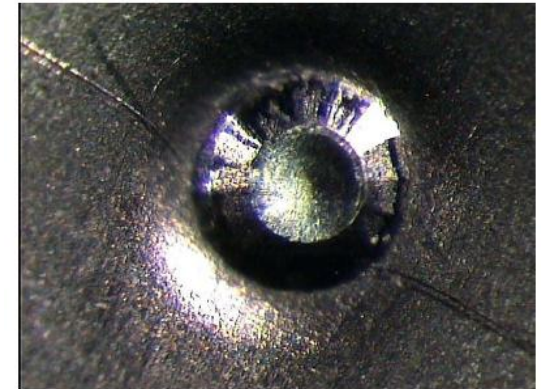

flat diameter (μ)	indentation thickness (μ)	P max (GPa)
>500	50-60	< 20
300	40-45	50-70
150	25-30	100-150
< 100	20-25	>150

- ◆ A hole in the pre-indented gasket is then drilled by electro-erosion or by a laser. The diameter of the hole depends critically on the diameter of the diamonds, and it is typically one third the diameter of the flat of the diamond

- ◆ The uniaxial compression of diamonds acts directly on the media that transmit hydrostatic pressure to the sample
- ◆ If the PTM solidifies, the hydrostatic conditions inside the cell volume are no longer achieved and the sample is subject to a pressure gradient: i.e. the stress is not uniform in all directions
- ◆ The variation of stress conditions at different points in the sample depends upon the strength of the PTM
- ◆ It is desirable to eliminate or reduce the pressure anisotropy and inhomogeneity in some HP experiments
- ◆ The PTM must not chemically react with the sample and must not interfere with the measurement of the sample

- ◆ Liquids (alcohol, alcohol mixtures (Me-Et 4:1), silicone oil)
 - ◆ Easy, fast, available
 - ◆ Low hydrostaticity limit (< 10 GPa)
- ◆ Soft solids (alkali halides, NaCl, KBr, etc)
 - ◆ Easy, good for laser heating, good insulation, can be annealed at high P, easy, available
 - ◆ Hydrostatic below 7-8 GPa, can react, hygroscopic
- ◆ Hard solids (MgO, Al₂O₃, etc)
 - ◆ Good thermal insulator for laser heating experiments
 - ◆ Nonhydrostatic
- ◆ Condensed gases (He, Ne, N₂, Ar, ...)
 - ◆ Best pressure medium for room and low temperature experiments
 - ◆ Difficult to load without gas-loading or cryogenic devices

- ◆ If the experimental technique is *in situ* XRD, then the diffraction pattern of an internal standard such as NaCl or Au, can be obtained along with that of the sample
- ◆ The pressure is then determined from the lattice parameters calculated from the diffraction pattern.

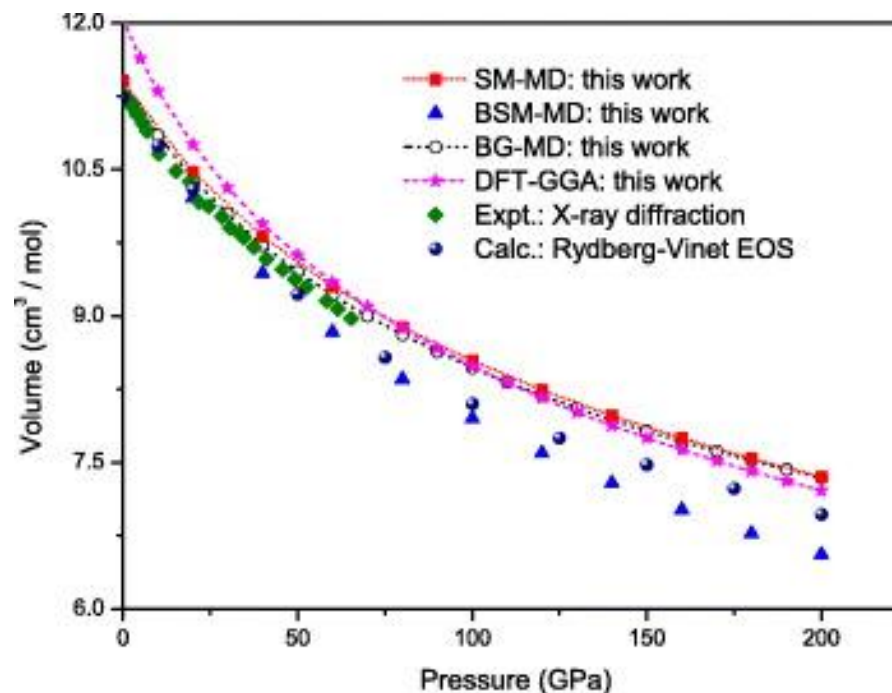

- ◆ Ruby fluorescence method
- ◆ It exploits the high transparency of the diamonds to visible light

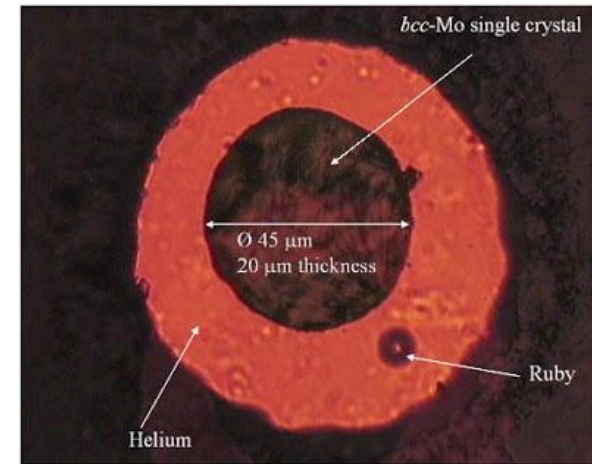

Example of pressure dependency of ruby fluorescence

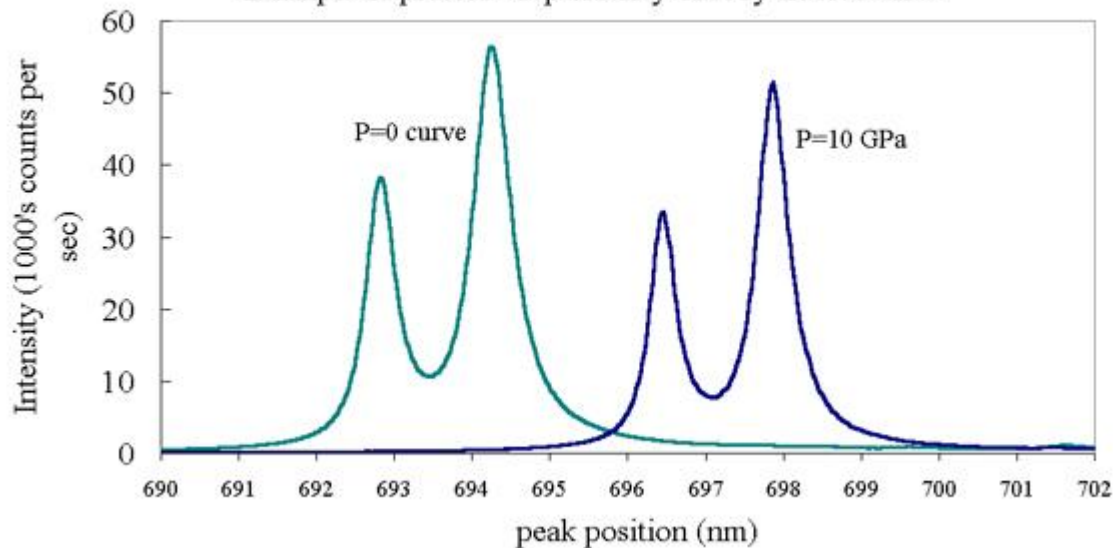

In this method a tiny chip of ruby (5-10 μm in dimensions) is placed in the pressure medium along with the sample, and its luminescence is excited by a laser. The shift in wavelength is followed as a function of pressure.



- ◆ Introduction
- ◆ Effects of pressure
 - ◆ Insulator to metal transitions
 - ◆ Metal to insulator transitions
 - ◆ Effects on magnetism
 - ◆ Structural phase transitions
- ◆ High pressure and Earth's science
- ◆ Tools and methods
- ◆ Examples of high pressure research using XAS
 - ◆ Polyamorphism in glassy GeO_2
 - ◆ Melting of iron at megabar pressures
 - ◆ Revealing Earth's interior
- ◆ Bibliography

Correlation between short and intermediate range order in compressed glassy GeO_2 studied by X-ray absorption spectroscopy

- ◆ Chemical analogue of SiO_2
- ◆ Archetypal network-forming glass
- ◆ Pressure-driven polyamorphism

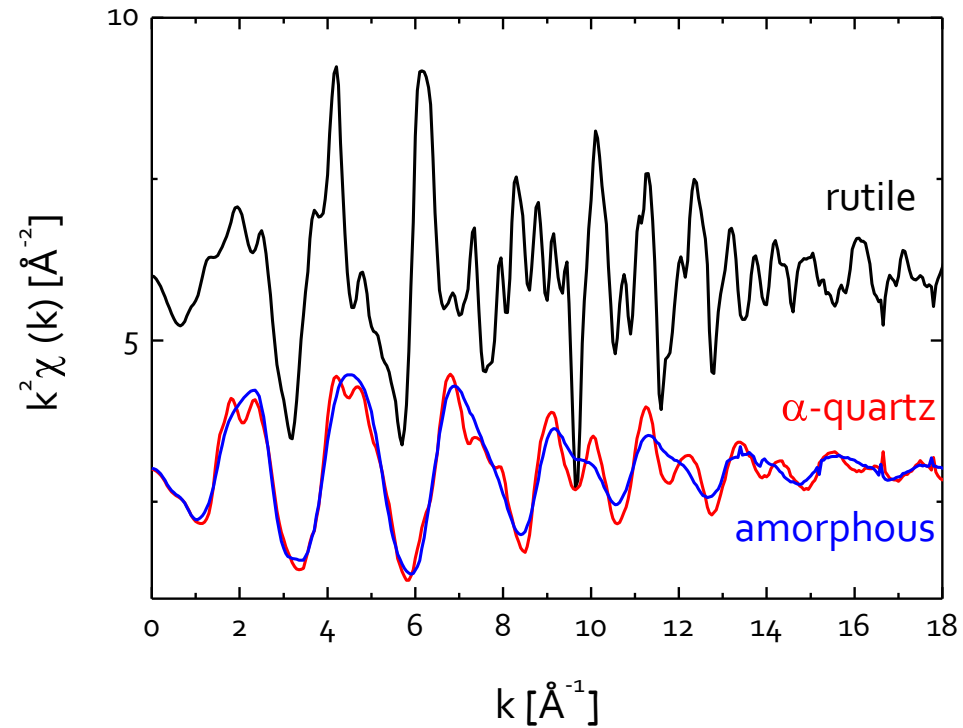
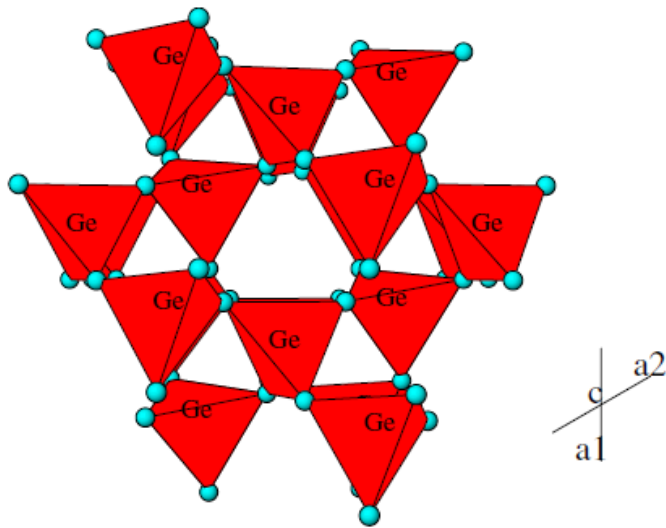

Figure 1. Projection of the α -quartz-like structure (left) and rutile-like structure (right) onto the (001) plane.

From Micoulaut, Cormier, Hendersen *JPCM* **18**, R753 (2006)

Pressure-Induced Coordination Changes in Crystalline and Vitreous GeO₂

J. P. Itie,⁽¹⁾ A. Polian,⁽¹⁾ G. Calas,⁽²⁾ J. Petiau,⁽²⁾ A. Fontaine,⁽³⁾ and H. Tolentino⁽³⁾

⁽¹⁾*Laboratoire de Physique des Milieux Condensés, Université de Paris 6, 75252 Paris, France*

⁽²⁾*Laboratoire de Minéralogie-Cristallographie, Universités de Paris 6 et 7
and Centre National de la Recherche Scientifique, 75252 Paris, France*

⁽³⁾*Laboratoire pour l'Utilisation du Rayonnement Electromagnétique, Centre National de la Recherche Scientifique,
Commissariat à l'Energie Atomique, Ministère de l'Education Nationale, Université de Paris-Sud, 91405 Orsay CEDEX, France*

(Received 21 February 1989)

In situ high-pressure x-ray-absorption spectra have been performed on amorphous and crystalline GeO₂ using a diamond-anvil cell adapted to an energy-dispersive spectrometer. The coordination of Ge changes from fourfold to sixfold at pressures between 7 and 9 GPa. The progressive evolution of the measured Ge-O distances as well as the modification in the x-ray-absorption near-edge structure indicate two different sites rather than a progressive site modification. The phase transition observed in the amorphous phase is reversible in contrast to that observed in the crystalline form.

PACS numbers: 64.70.-p, 61.40.+b, 62.50.+p, 78.70.Dm



Compaction mechanism

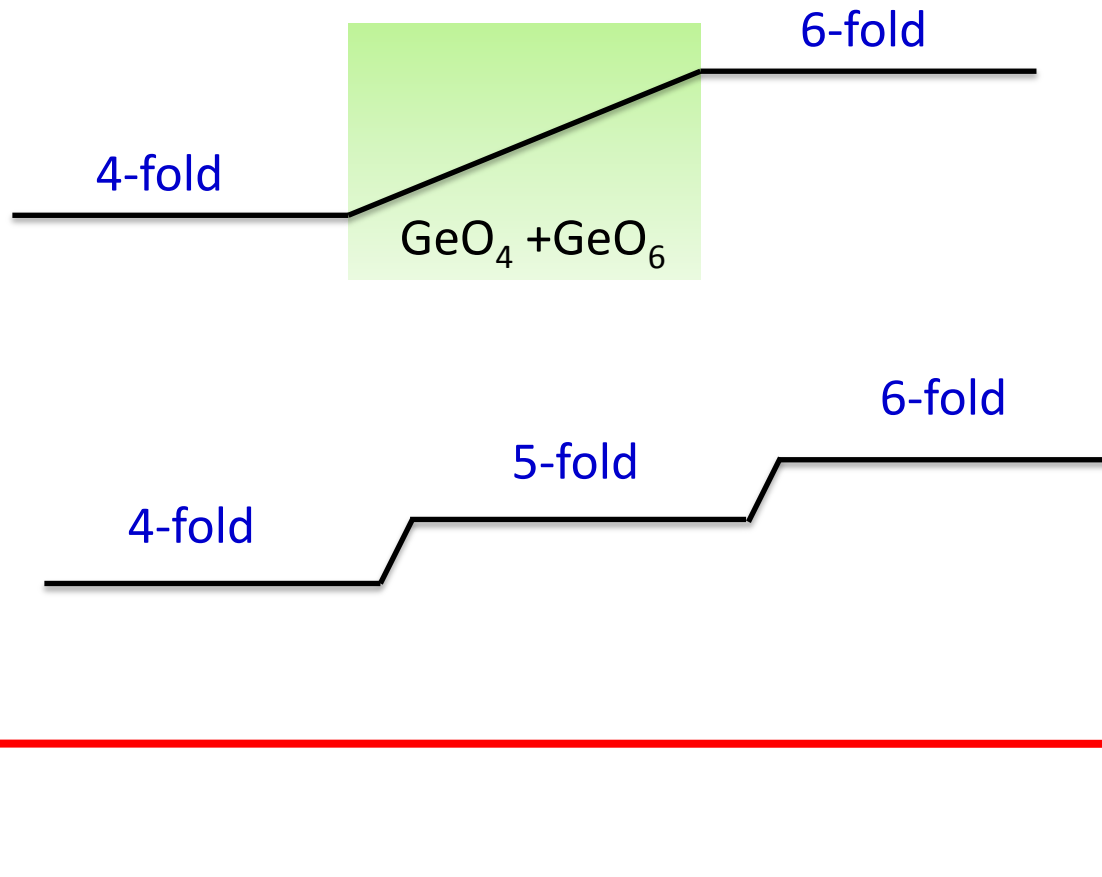

- ◆ IRO in network forming glasses with AX₂ stoichiometry
- ◆ Tetrahedral units assembled in the 3D network
- ◆ Length scale periodicity: $2\pi/Q$

At HP:

Measurements on densified glasses and in-situ
Broadening and shift to higher Q of the FSDP



Reduction of the length scale of the IRO i.e. a breakdown in the network

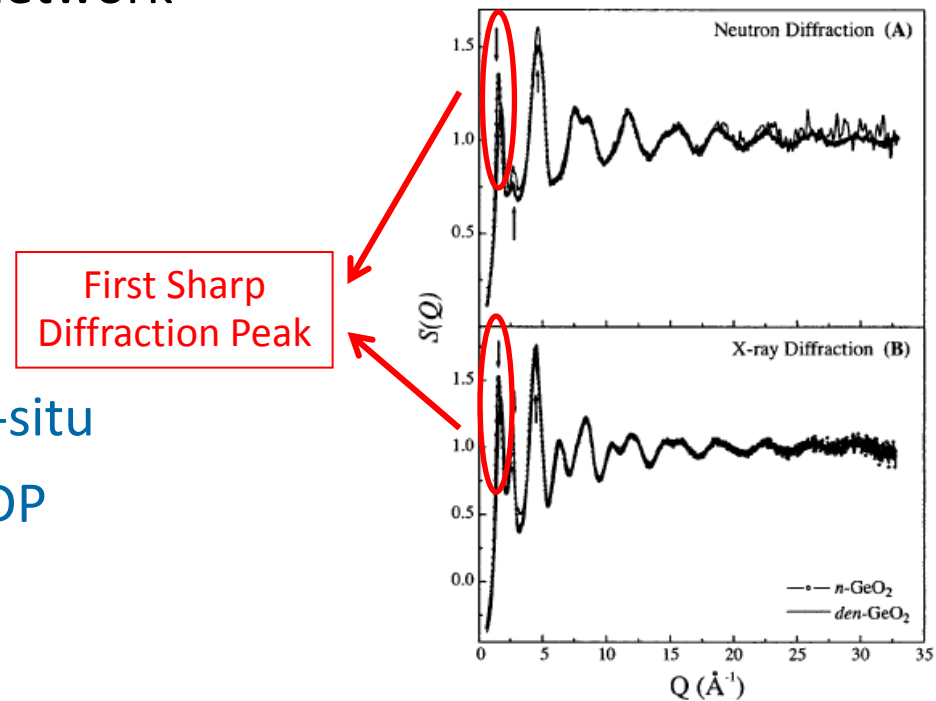

Correlation between intermediate and short range order

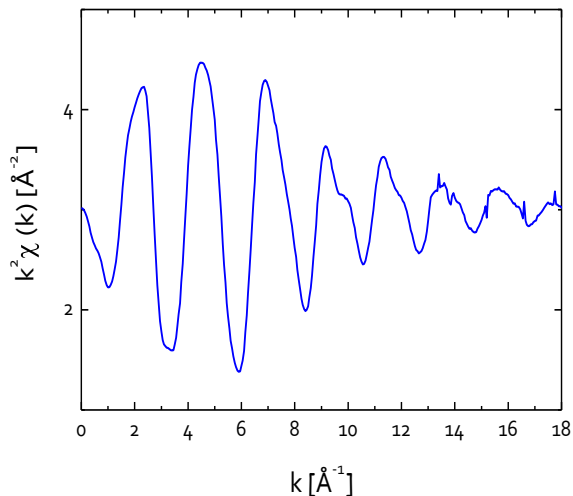

$$\chi(k) = \frac{\sigma(E) - \sigma_0^t(E)}{\sigma_0}$$

$$k = \sqrt{\frac{2m(E - E_0)}{\hbar^2}}$$

$$A(k) \sin[2kR + \phi(k)]$$



Fourier transform analysis

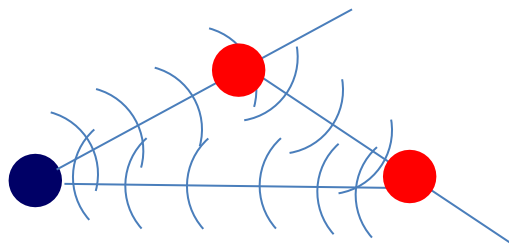

XAS is sensitive to atomic arrangements involving more than two atoms at the same time through multiple scattering processes

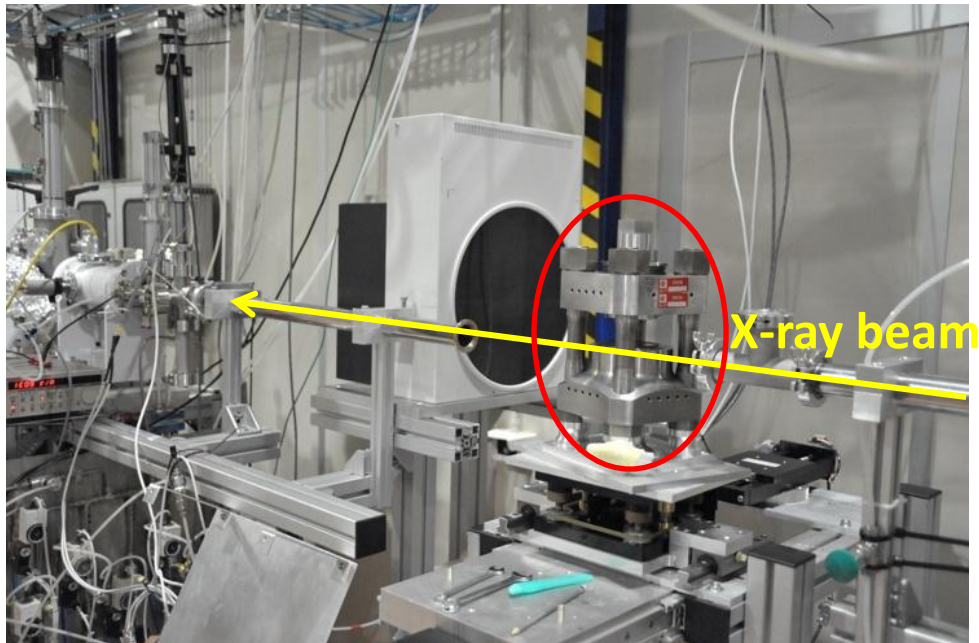

- ◆ Ge K – edge
- ◆ glassy GeO_2 mixed with BN
- ◆ Image plate for ADXRD ($E = 15 \text{ keV}$)
- ◆ 7 mm boron epoxy gasket
- ◆ P from ambient to 5.1 GPa

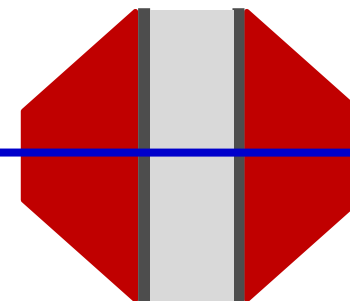
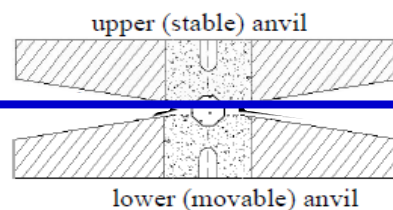
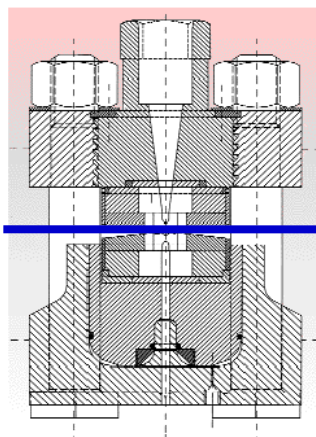

X-ray beam



The data: qualitative analysis

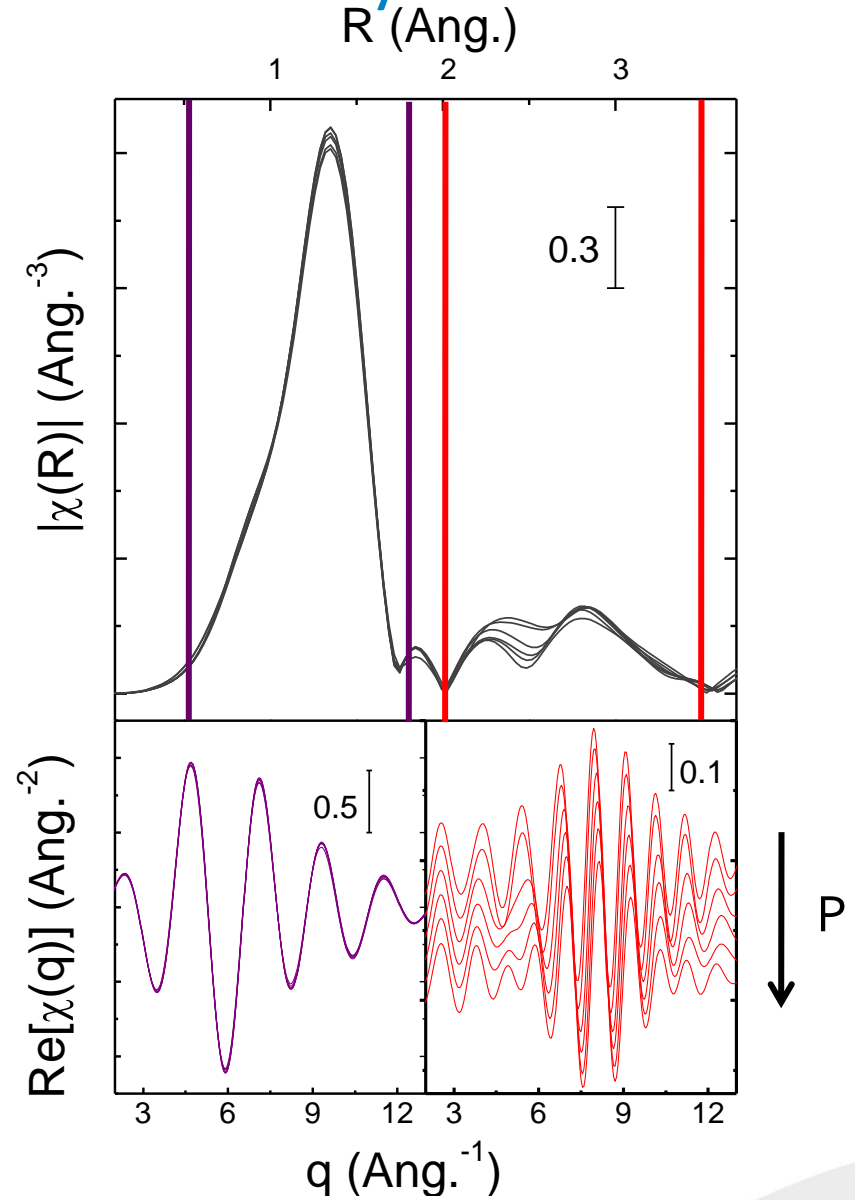
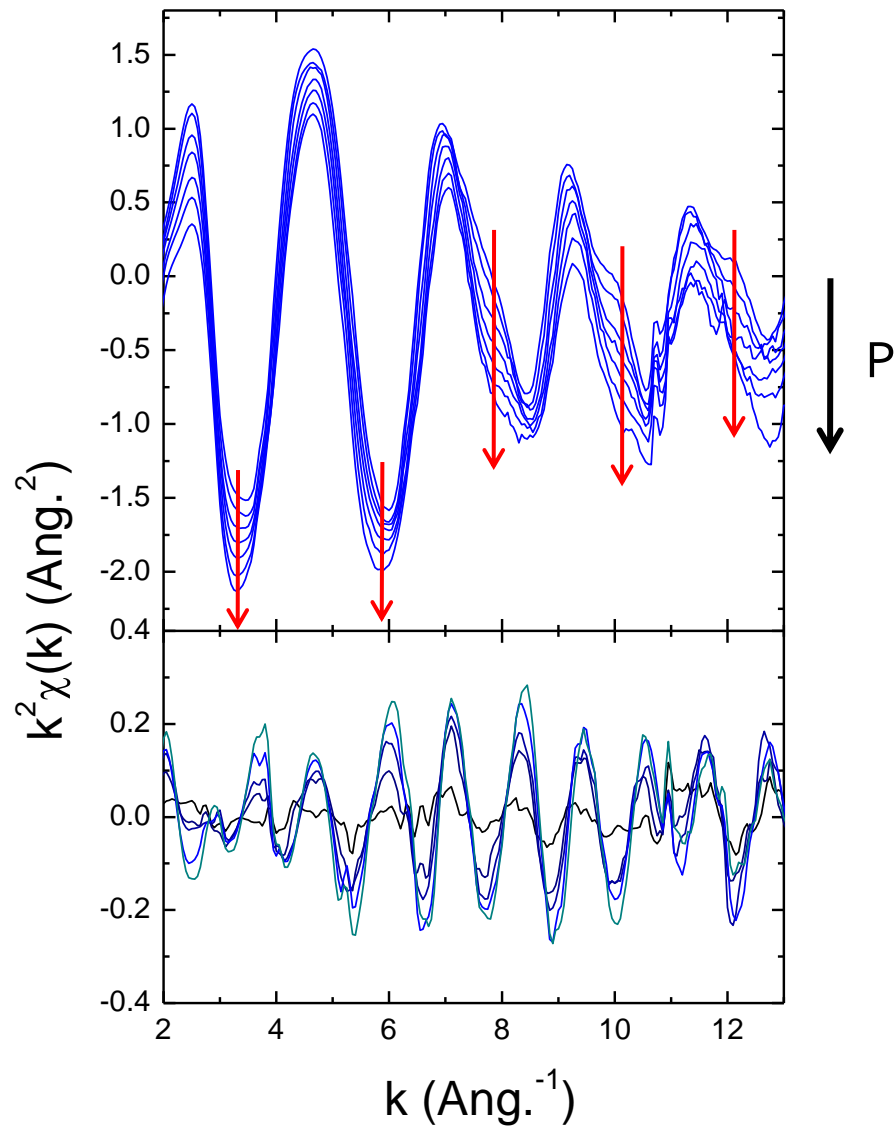

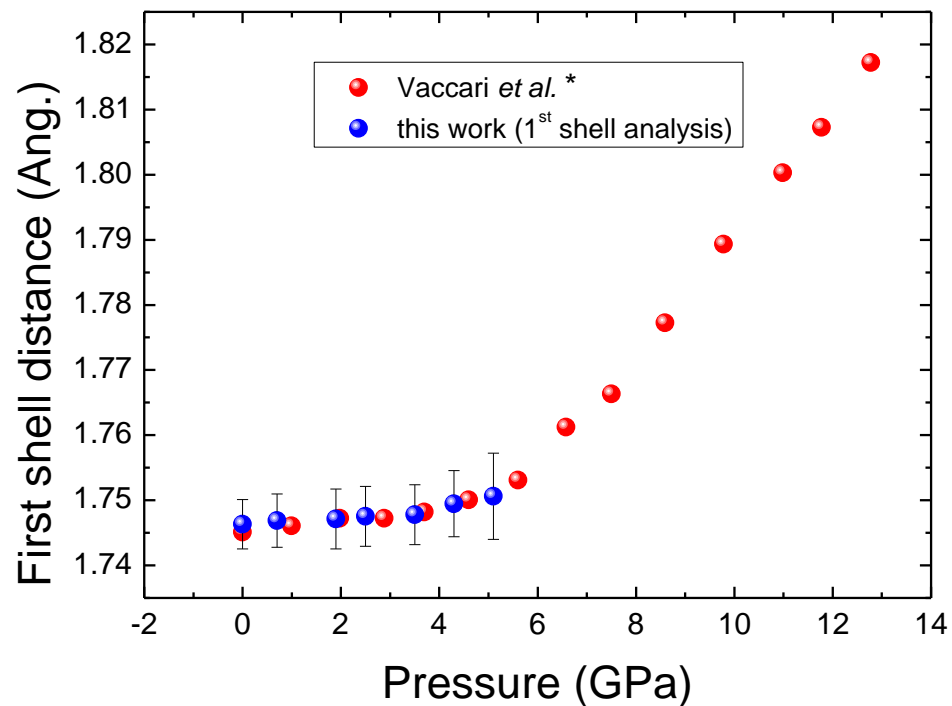
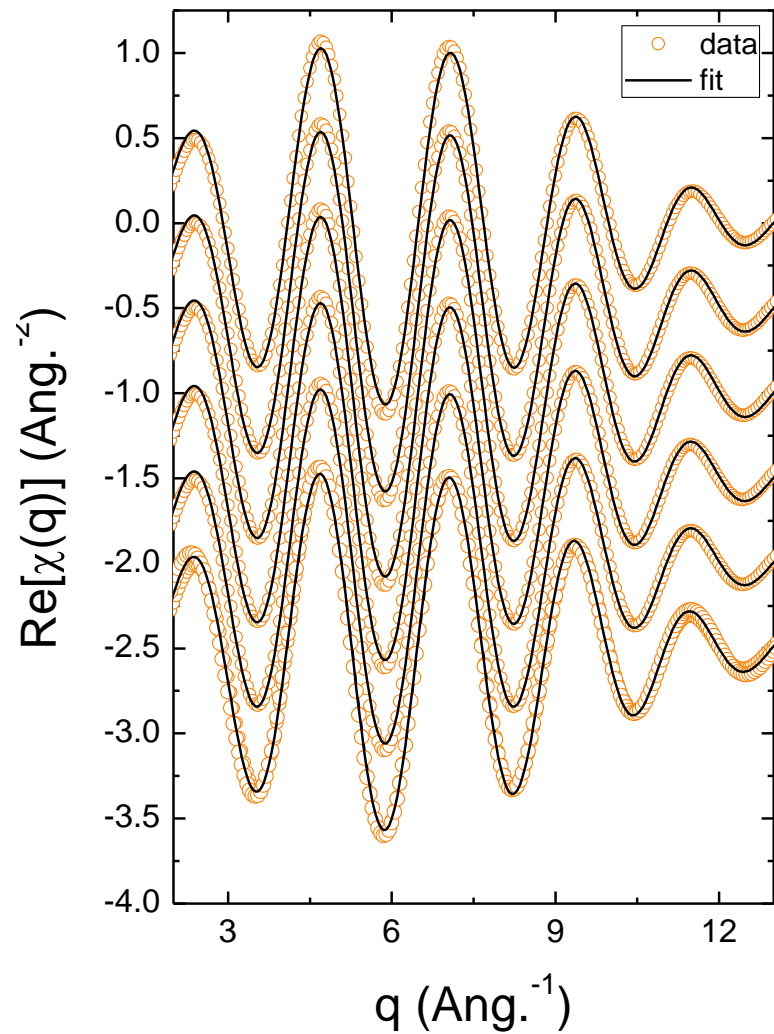

* M. Vaccari *et al.*, *J.Phys.Cond. Matt.* **21**, 145403 (2009)

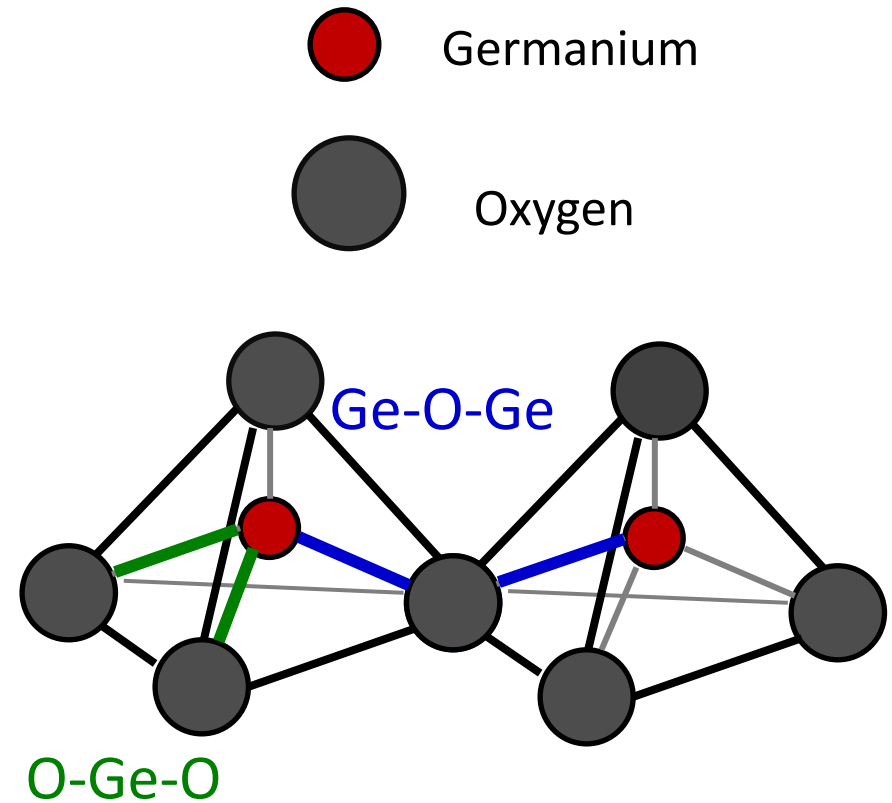
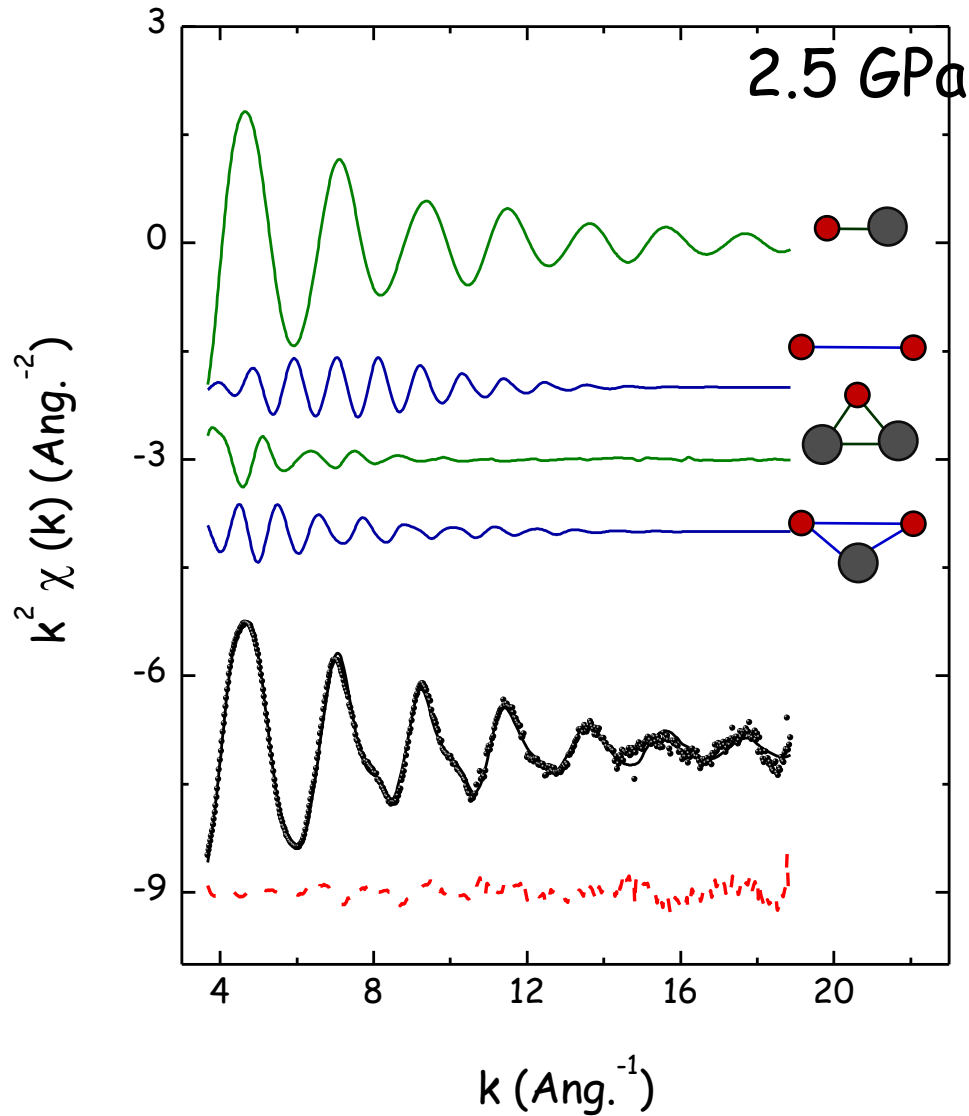

Results: distances and angles

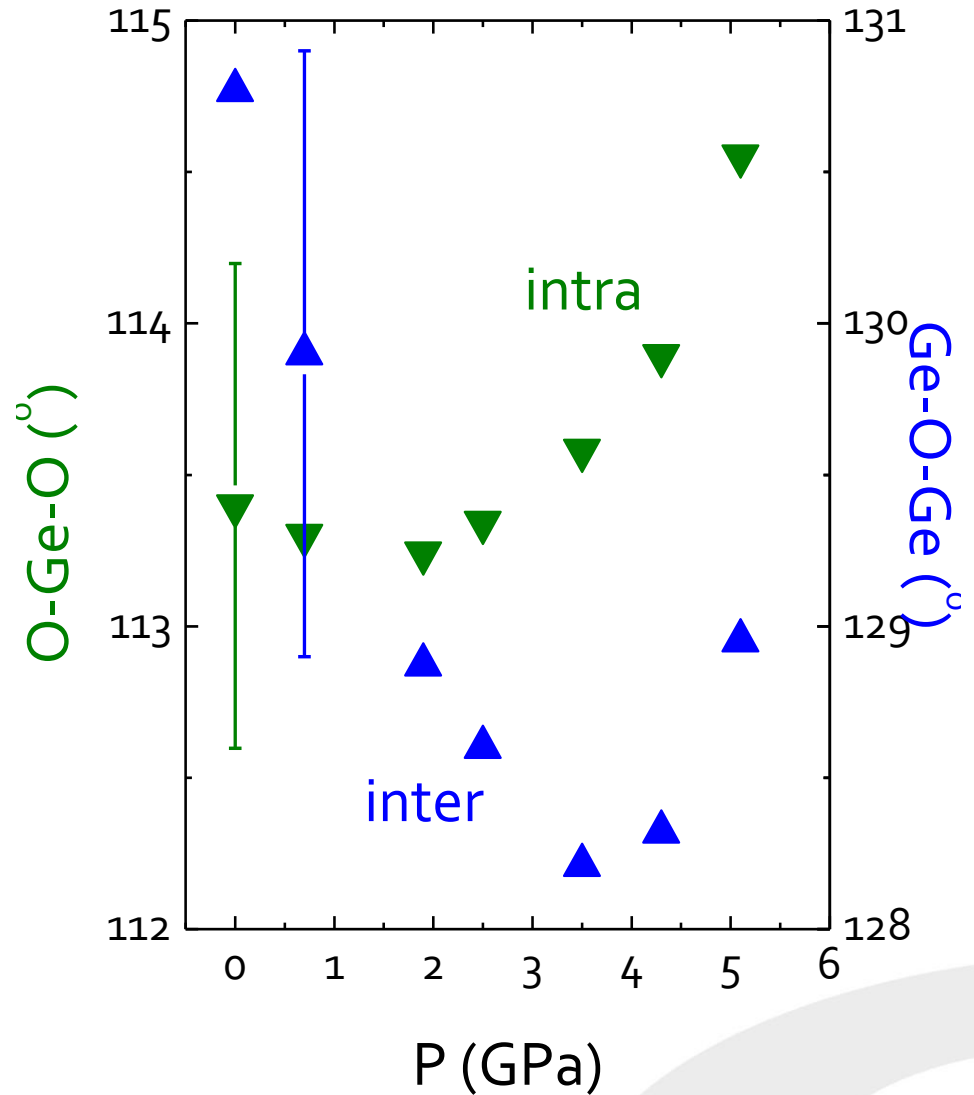
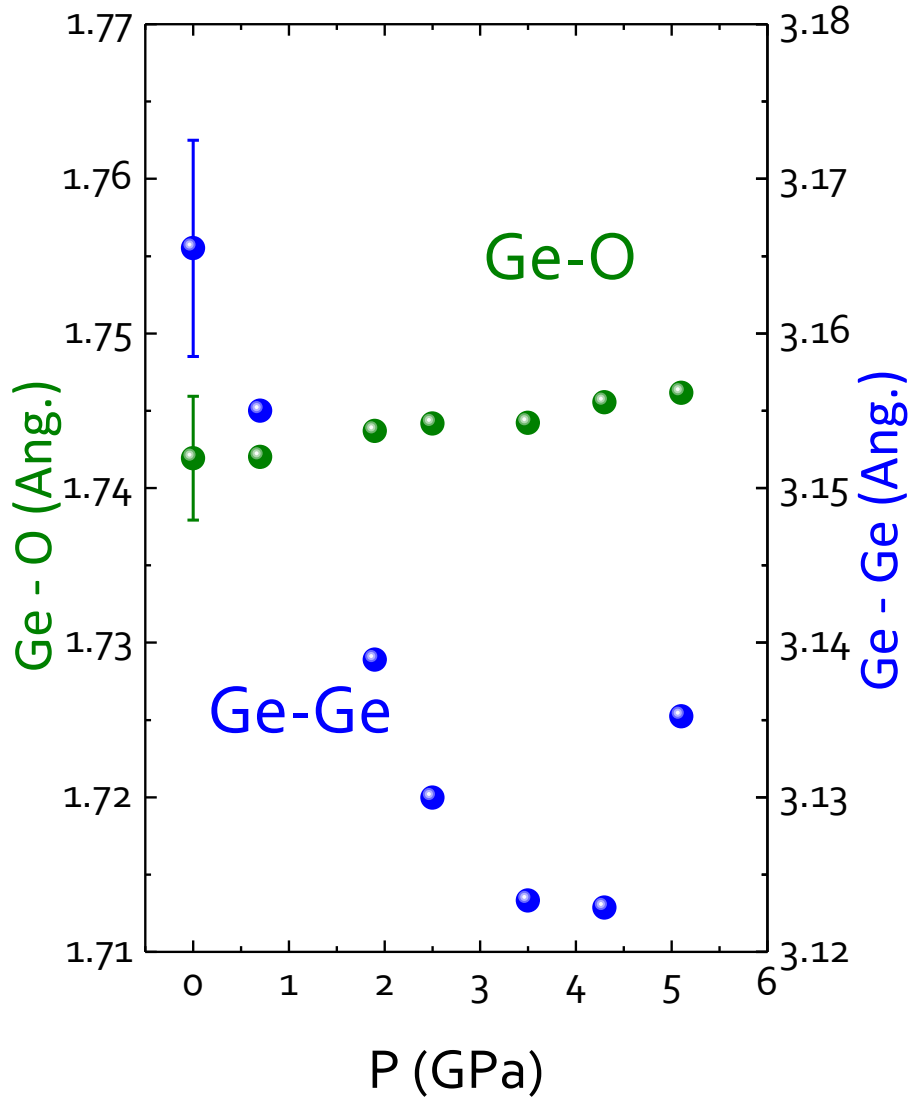
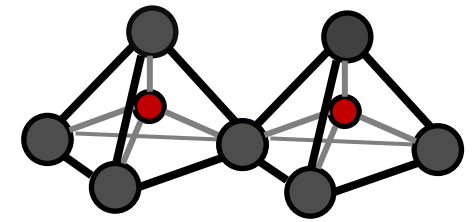



Results: variances

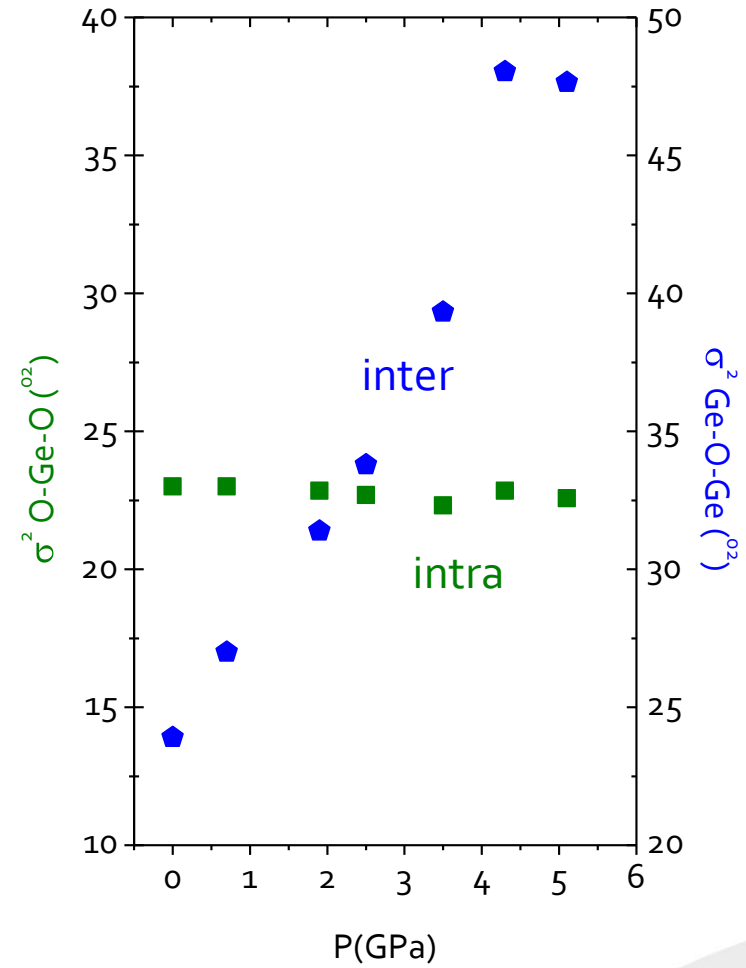
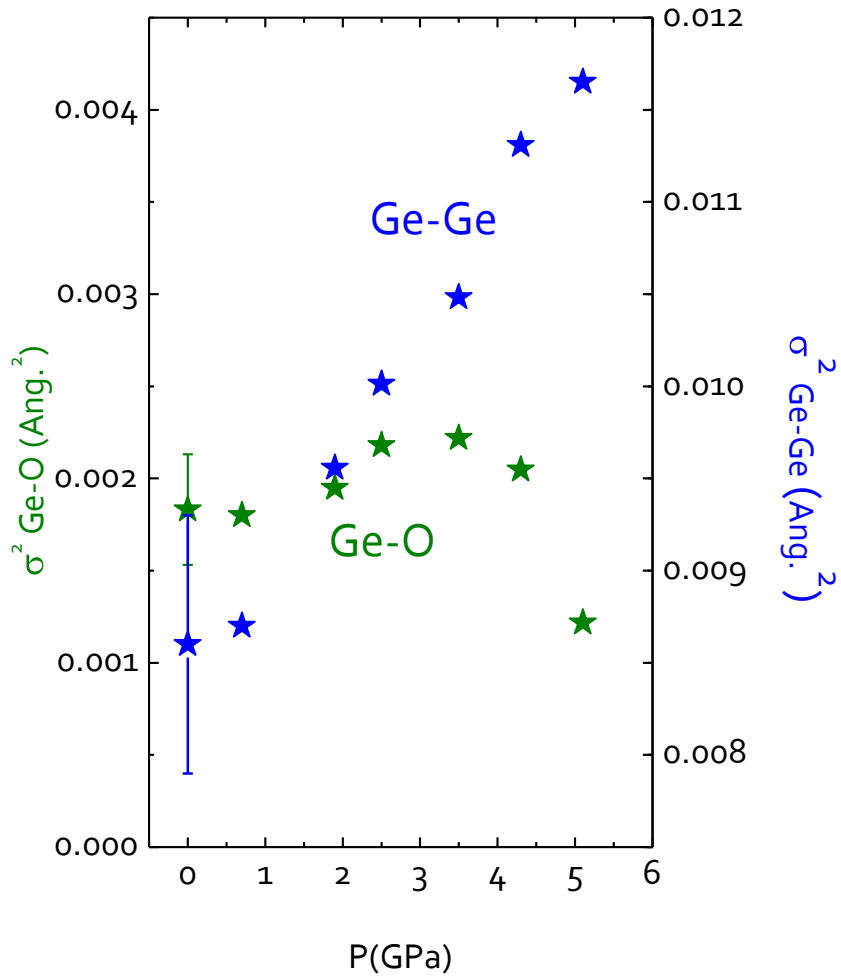
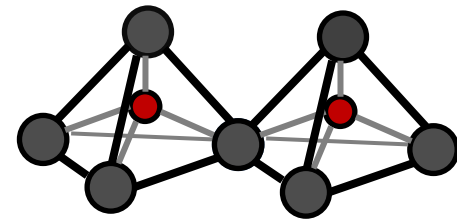

- ◆ Multiple scattering approach has been applied to EXAFS data of compressed glassy GeO_2
- ◆ Angular distributions have been determined as a function of pressure

- ◆ A change of the IRO occurs as soon as the pressure is applied
- ◆ It is the relative position between the tetrahedra that plays the major role in the of the IRO although the basic units deform to some extent
- ◆ The pressure induces an increasing disorder both at the Ge-Ge distance distribution and at the Ge-O-Ge (intertetrahedra) angular distribution



Melting of iron at extremes pressures

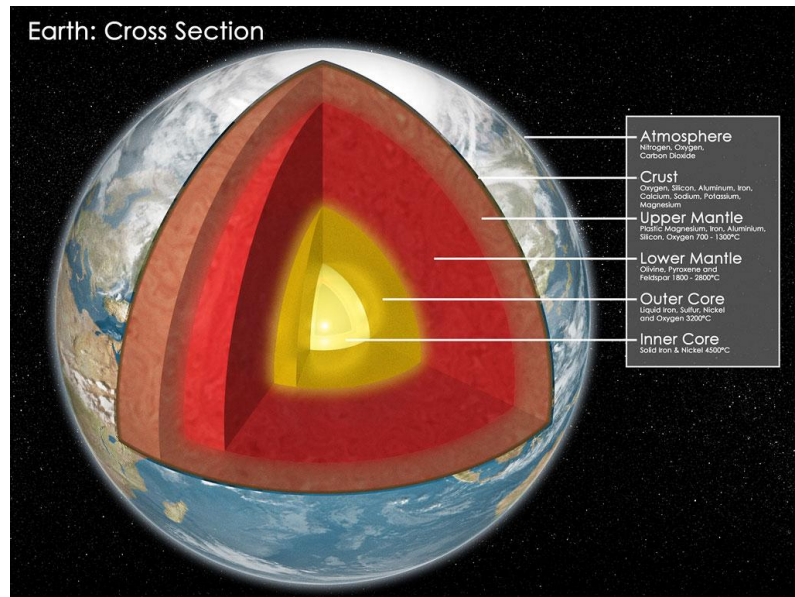

- ◆ Fe is the principal component of the Earth's core
- ◆ The knowledge of the melting curve is a major concern in geophysics
- ◆ The melting temperature of iron at ICB (330 GPa) constraints the thermal gradient and thus the heat fluxes
- ◆ This is fundamental to understand the Earth's dynamo and its implications to the terrestrial magnetic field
- ◆ Discrepancies as large as 2000 K at the ICB (800 K at 100 GPa)

- ❖ XAS (XANES) is used to detect melting on iron compressed to over 100 GPa
- ❖ XAS maintains the same accuracy and sensitivity regardless the physical state of the investigated sample
- ❖ Similarly to diffraction techniques, XANES may distinguish different crystallographic phases, but gives in addition information on electronic structure
- ❖ The XANES spectra contain solely the signal relative to the absorbing element, without any interference of the container or experimental environment

EDXAS allows fast (from ns to few s) acquisition of the whole spectrum with a small (< 5mm) x-ray focal spot

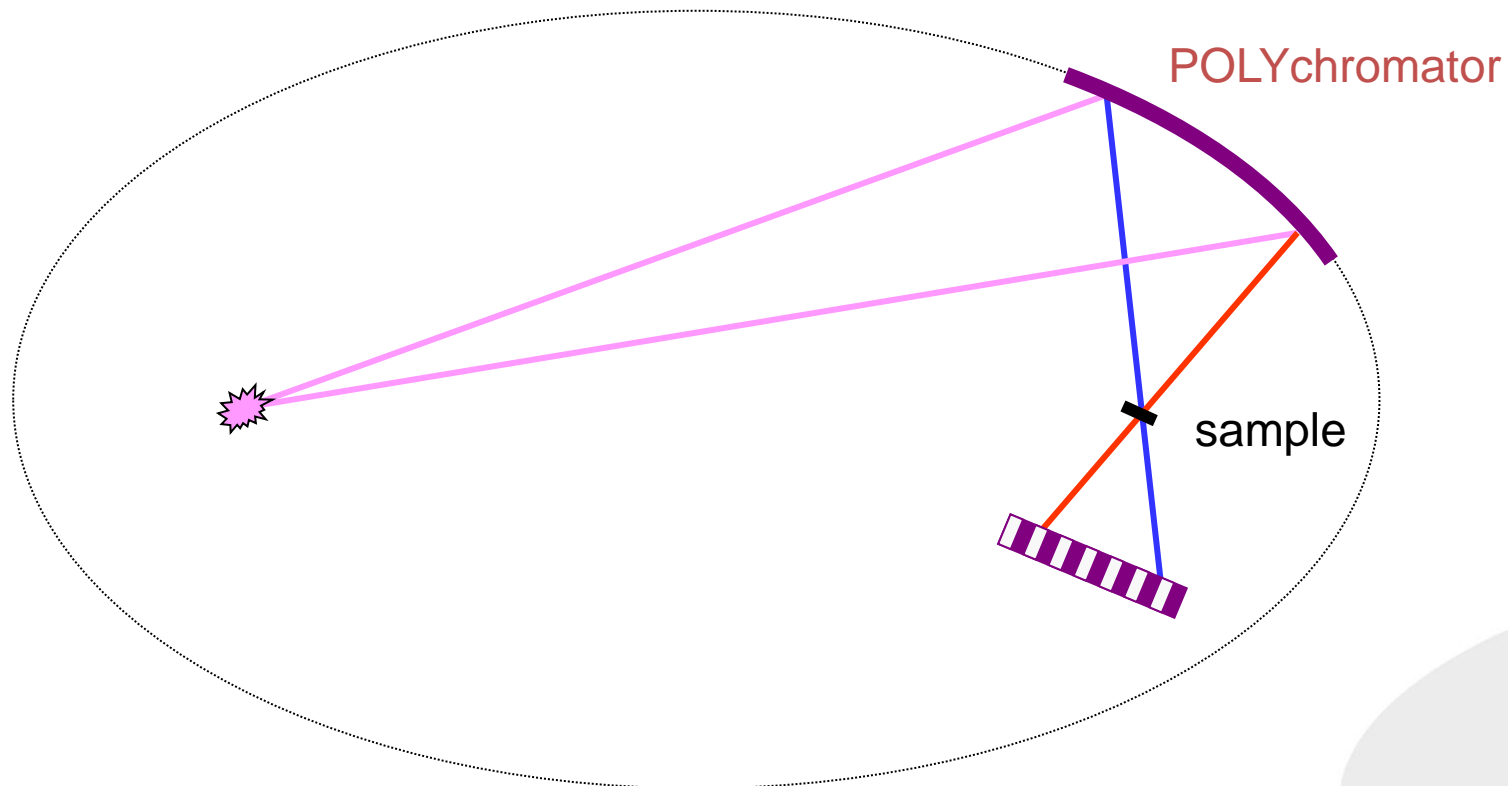

- Novel sample encapsulating technique
- The sample container consists of two sapphire plates manufactured using a combination of micro polishing and focused ion beam milling
- The cavity dimension: 18 μm diameter and 6 μm depth
- All is embedded in a very fine grained Al_2O_3 powder which molds around the capsule to prevent fracture during loading and after laser heating

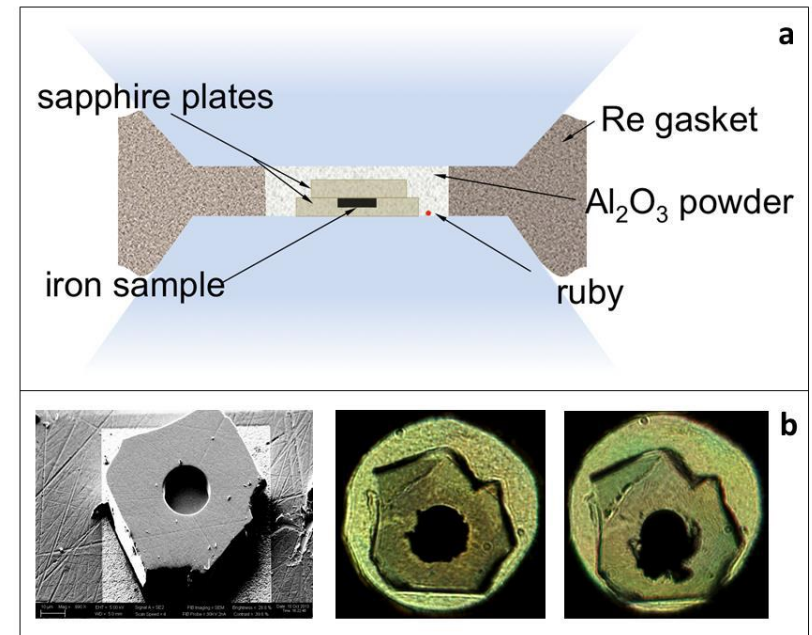

XANES measurements at ID24 (ESRF)

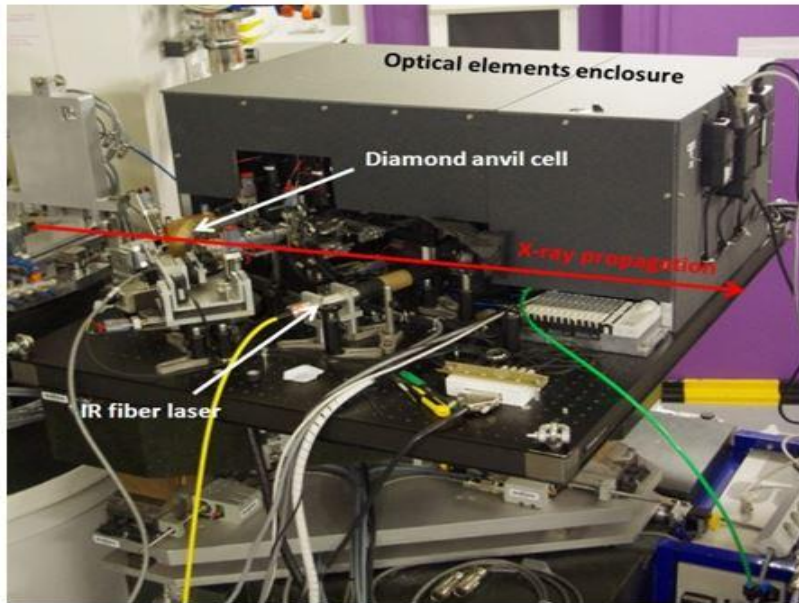

- X-ray beam size: $5 \times 5 \mu\text{m}^2$
- XANES spectra collected every few seconds before, during and after heating
- Four different runs from 63 to 103 GPa and temperatures up to 3530 K
- For each heating cycle, the laser power is ramped up incrementally and kept constant for several seconds to record the XAS spectrum and light emission to measure the temperature.

hcp to fcc phase transition

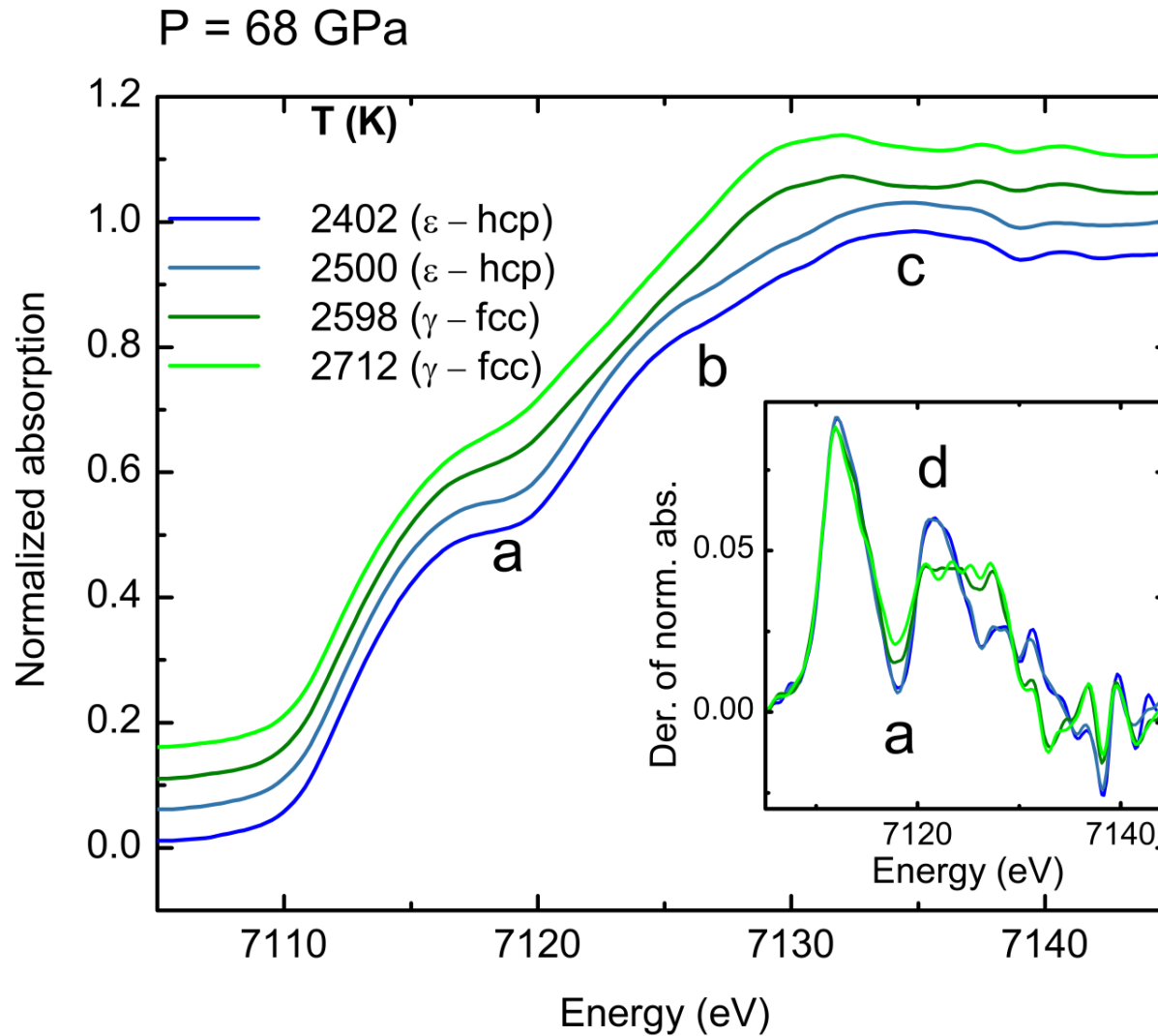

- The modification of the onset of absorption can be used as a signature for the solid to liquid phase transition
- The data show a discontinuous (although subtle) behavior
- The derivatives of the XANES highlight this change with the minimum 'a' flattening abruptly

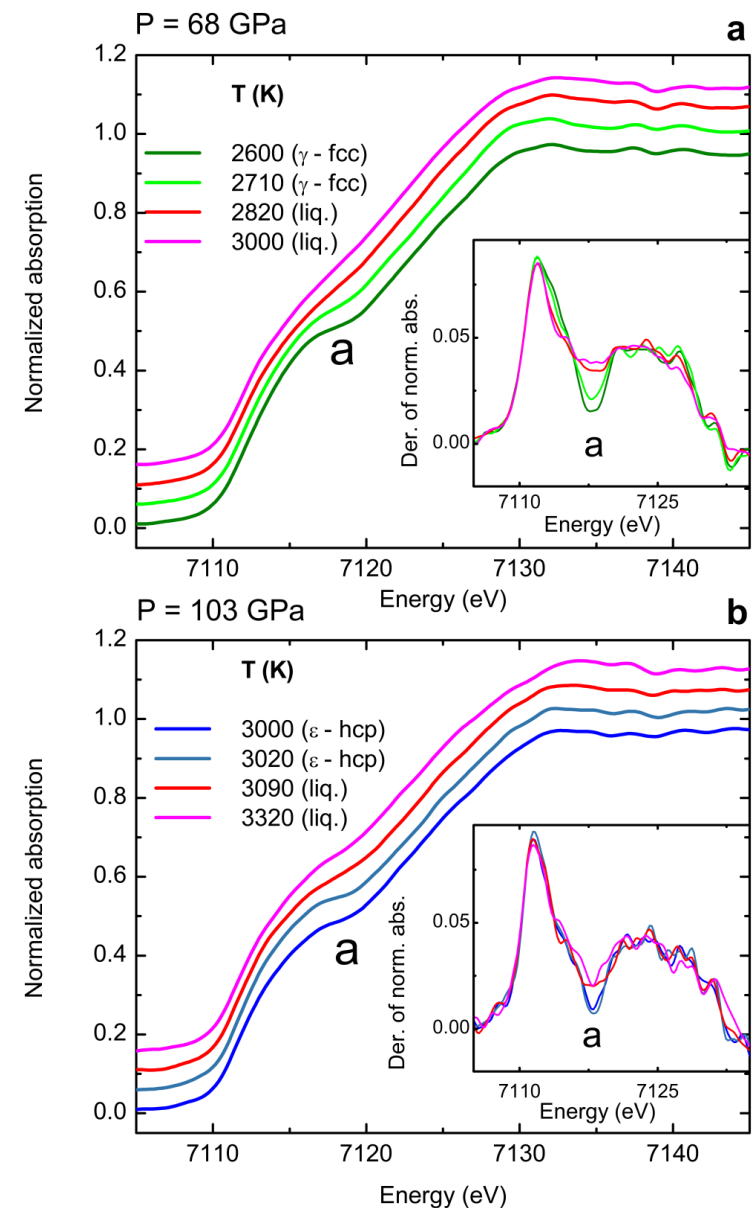

- The XAS experiment provides continuous monitoring of the changes of both the atomic and electronic structure as a function of temperature
- The melting criterion here adopted is based on changes occurring in the XANES that is known to be less affected by thermal damping and by the noise associated with extreme experimental conditions
- The detection of the new phase does not appear gradually as a weak background superimposed to a much larger signal as in XRD methods, but as a discontinuous change in the XANES signal which has similar amplitude with respect to that in the solid phase.

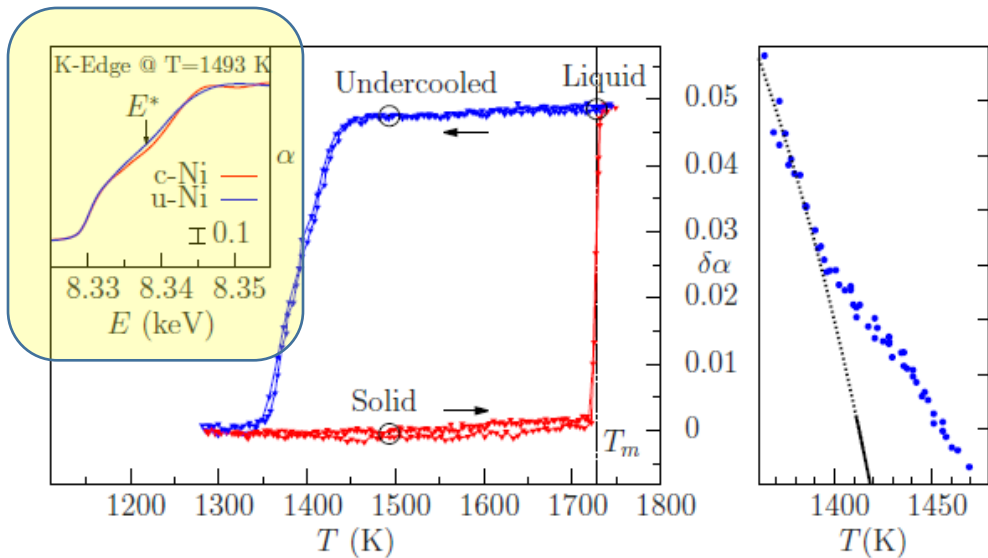

Nickel

A. Di Cicco, F. Iesari et al.,
PRB **89** (2014) 060102

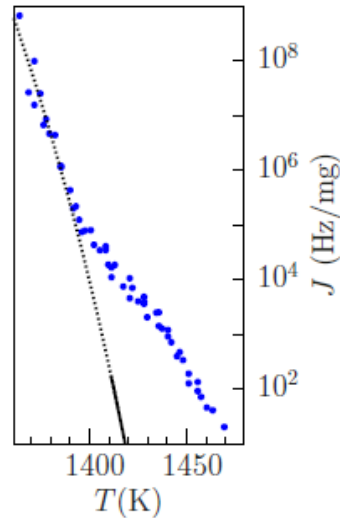

Copper

A. Di Cicco and A. Trapananti
J. Non Cryst. Sol. **353** (2007) 3671

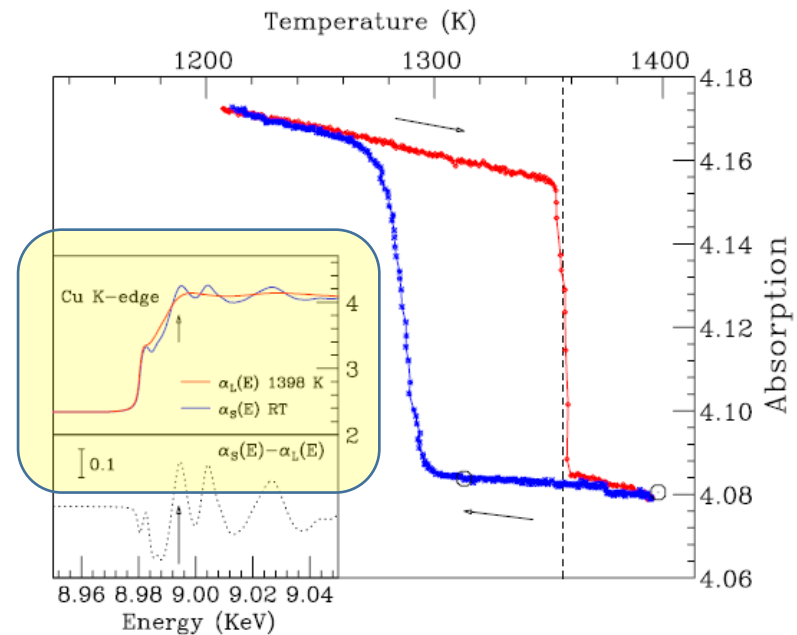

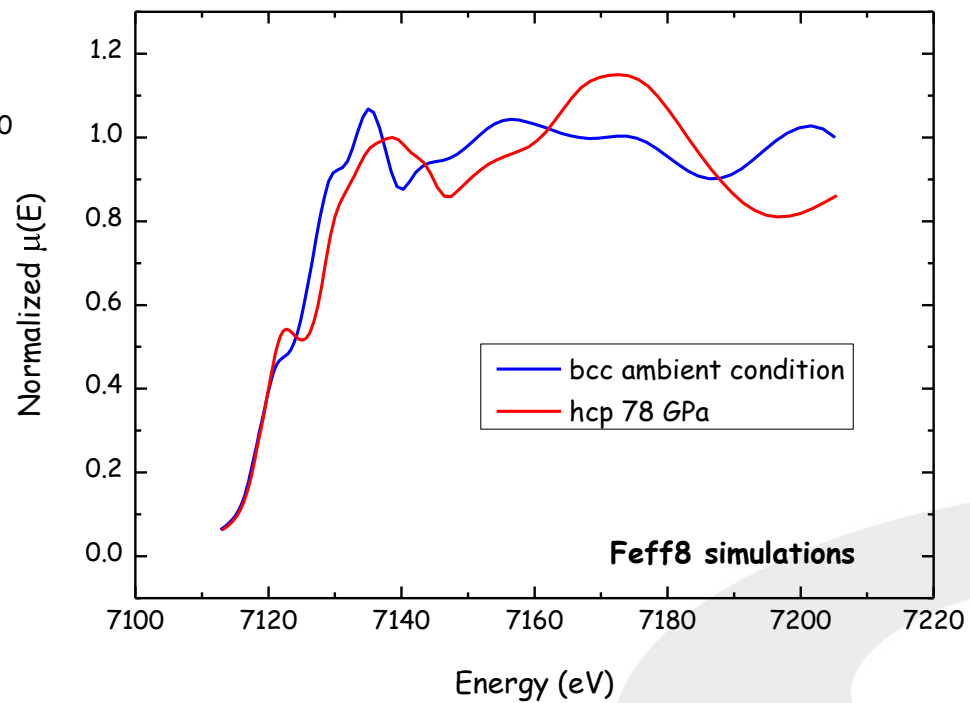
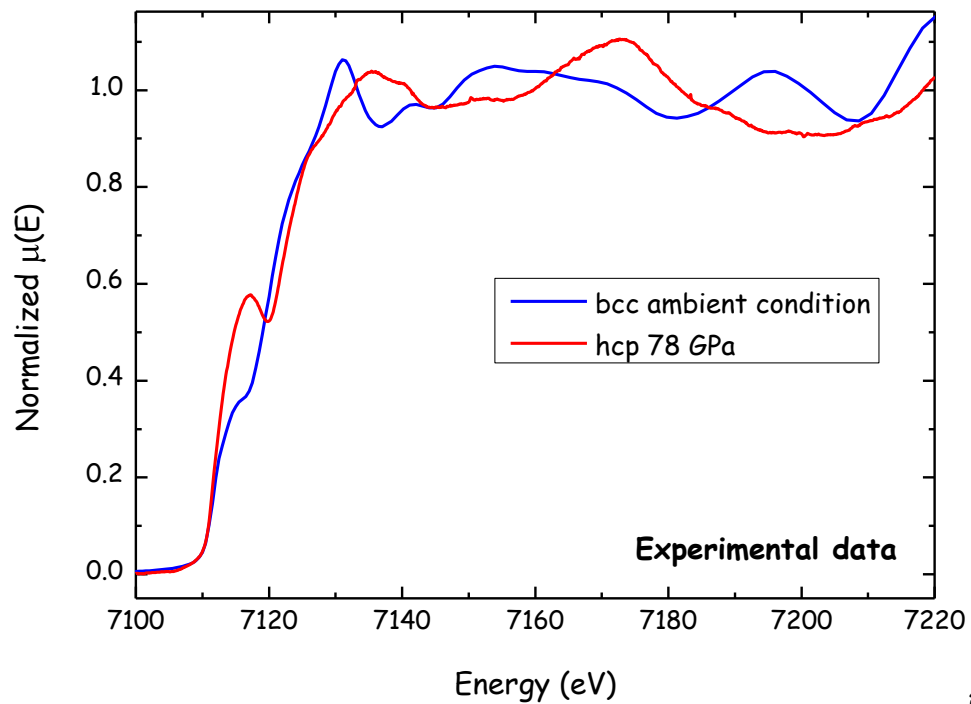

- ONE single cluster cannot describe the structure of the liquid
- Average over several configurations
- Configurations obtained using the EPSR method

EPSR (Empirical Potential Structure Refinement)

A.K. Soper, J. Phys.: Condens. Matter (2007) **19**, 415108

Computational method for building atomic and molecular structural models of disordered materials, such as liquids that are consistent with available structural data and known physical/chemical constraints

INPUT

- Experimental data ($S(q)$)
- Monte Carlo simulation with an Empirical Potential iteratively refined to reproduce the experimental data

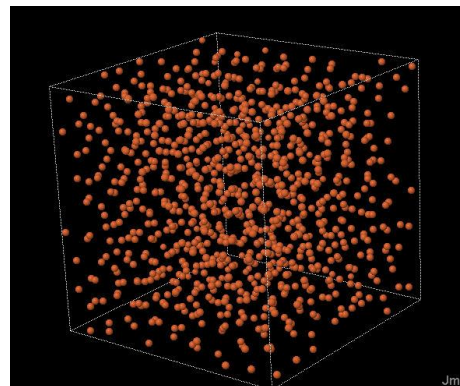



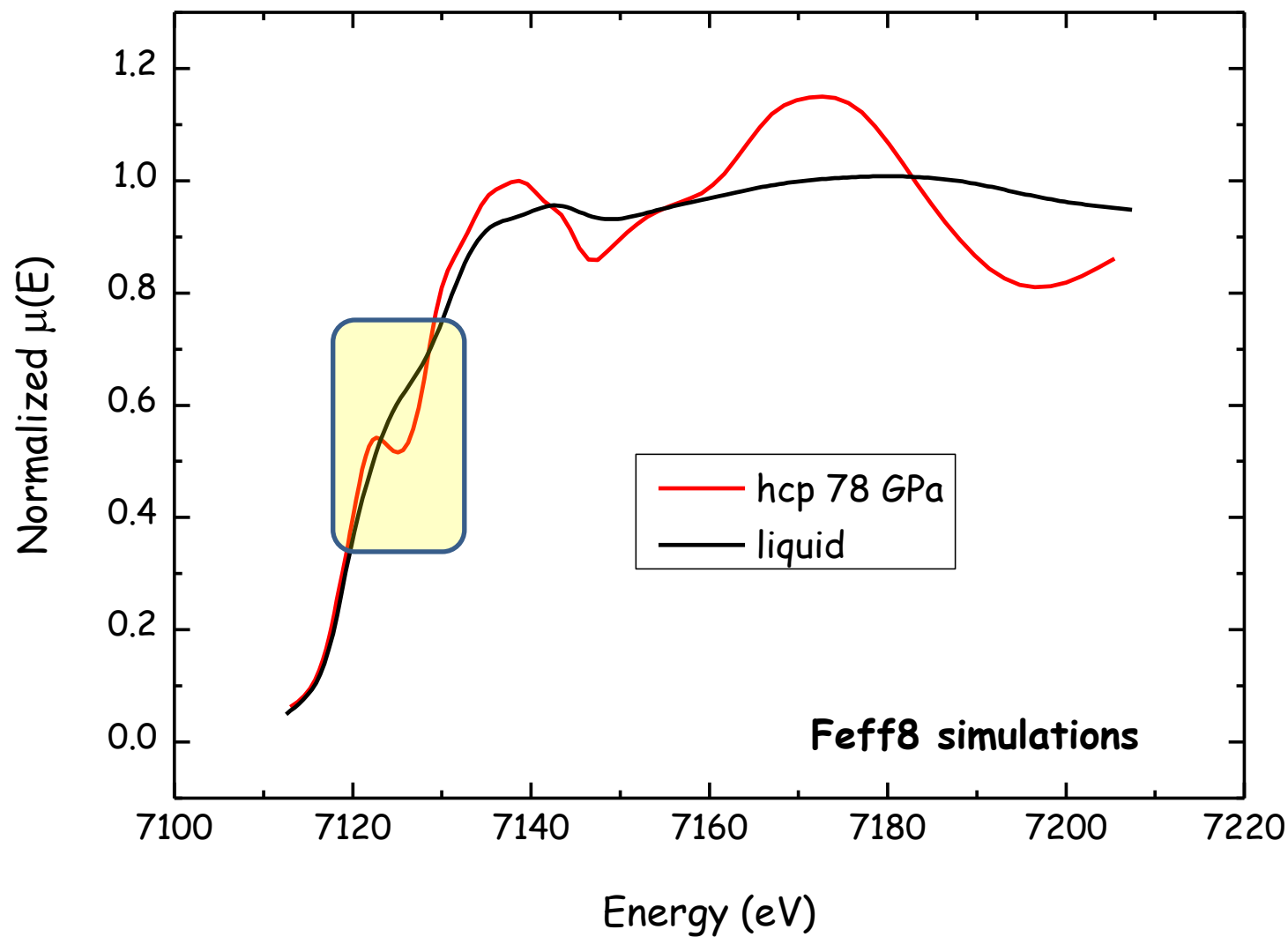

OUTPUT

- 3-dimensional structural model

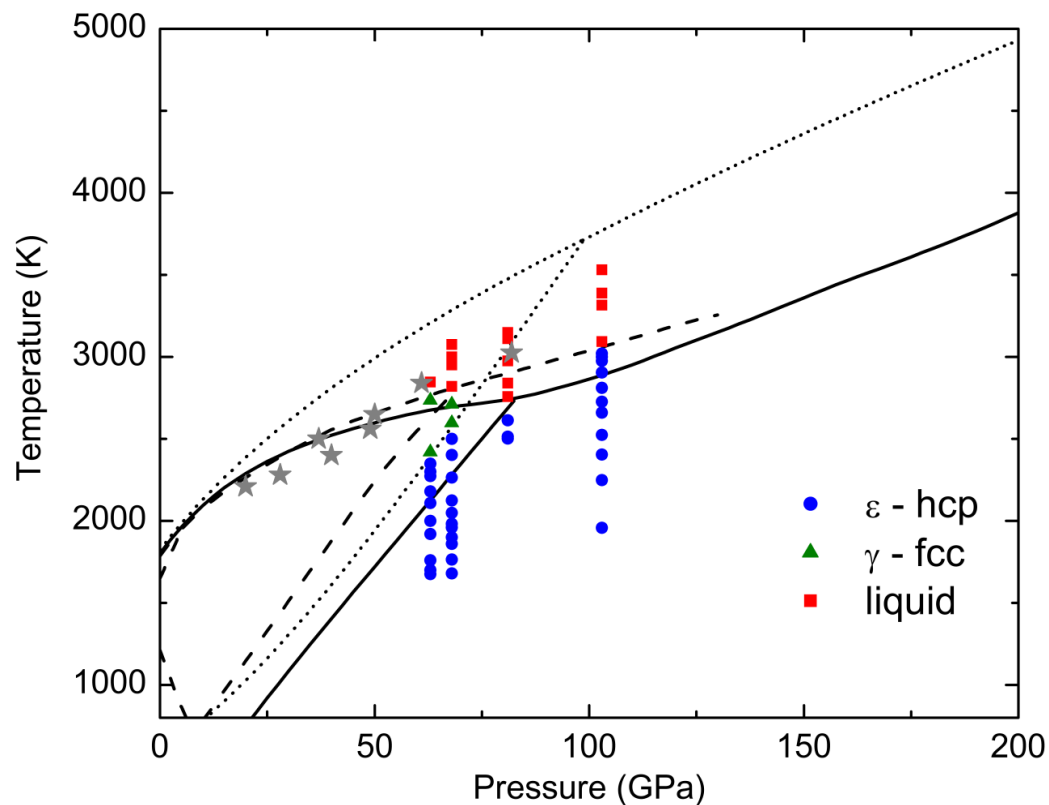
Simulations for the liquids - 2





-  Excellent agreement for the hcp -Fe to fcc-Fe transition reported earlier
-  Flat melting curve near 3000 K at 100 GPa
-  Melting temperature at ICB near 5000 K



Decomposition of ringwoodite at high P and T

At 660 km below the Earth's surface (P=23 GPa, T=1600 °C), the properties of the Earth's mantle change abruptly

- increase of density
- increase of transmission speed of seismic waves

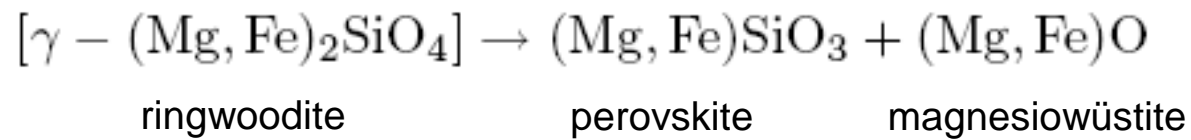

Pv and Mw form the most abundant assemblage in the Earth

$K_{\text{Mw/Pv}}^{\text{Fe}}$ is crucial for:

- composition and physics of the lower mantle
- interaction between the lower mantle and the liquid core
- stability field of Pv and Mw

- ◆ Fe K-edge (7112 eV) XANES maps
- ◆ In transmission mode in a DAC
- ◆ As a function of pressure up to ~ 40 GPa, before and after laser heating
- ◆ Each map: $200 \times 200 \mu\text{m}^2$ with $5 \mu\text{m}$ spatial resolution 1600 spectra in ~ 3 hours
- ◆ The spectra are automatically treated using a Matlab program performing the basic operations of normalization and the information are stored in 2D matrices
- ◆ Different kinds of maps can be produced:
 - ◆ absorbance at a given energy
 - ◆ edge position
 - ◆ absorption jump intensity

Absorbance at 7125 eV

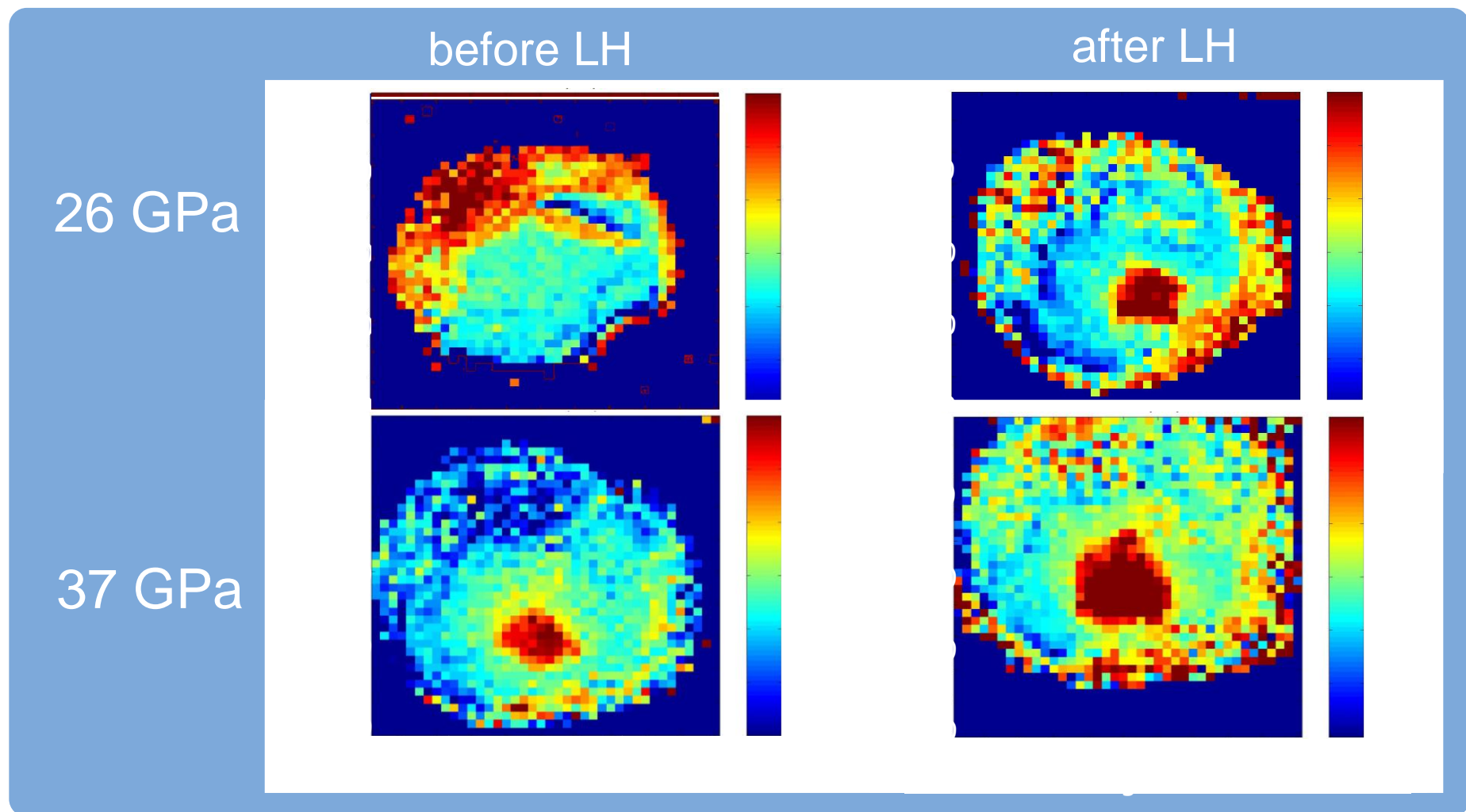

- Fe K-edge XANES spectra recorded every 5 mm through the hot spot
- Fe speciation is modified upon laser heating, i.e. with temperature

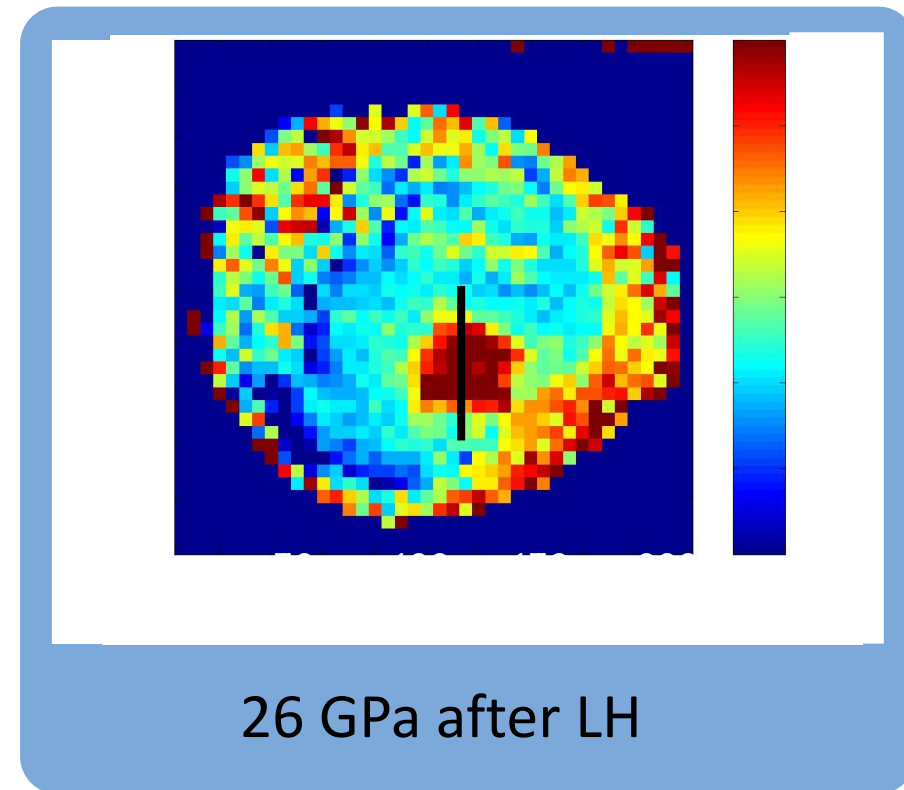
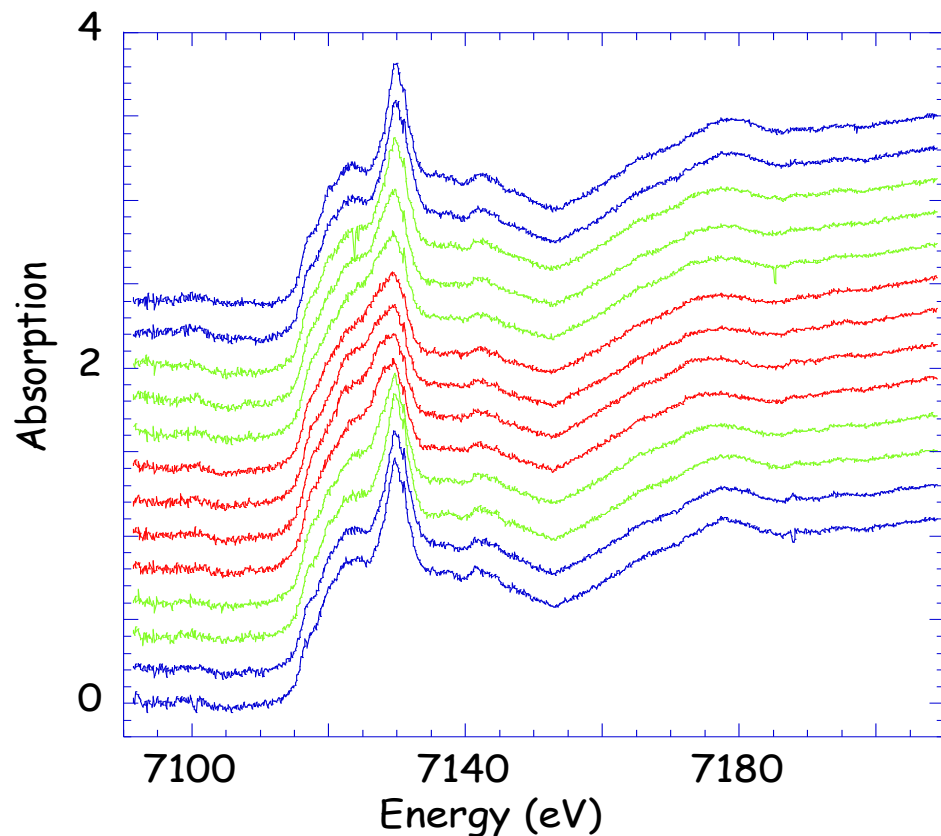

26 GPa after LH

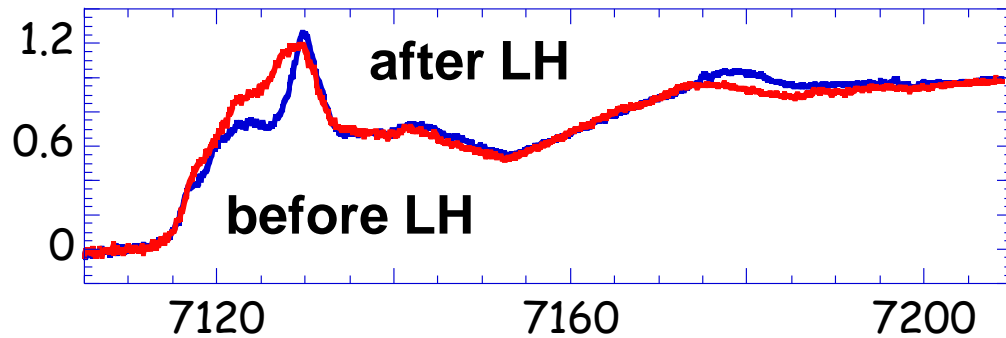

- ◆ The sample at the hot spot is a mixture of Rw, Pv and Mw
- ◆ The spectra at the hot spot contain a sum of the three contributions

- ◆ The sum decomposition can be done using model spectra
- ◆ The relative intensity of each characteristic signal will directly inform on the $K^{\text{Fe}}_{\text{Mw/Pv}}$

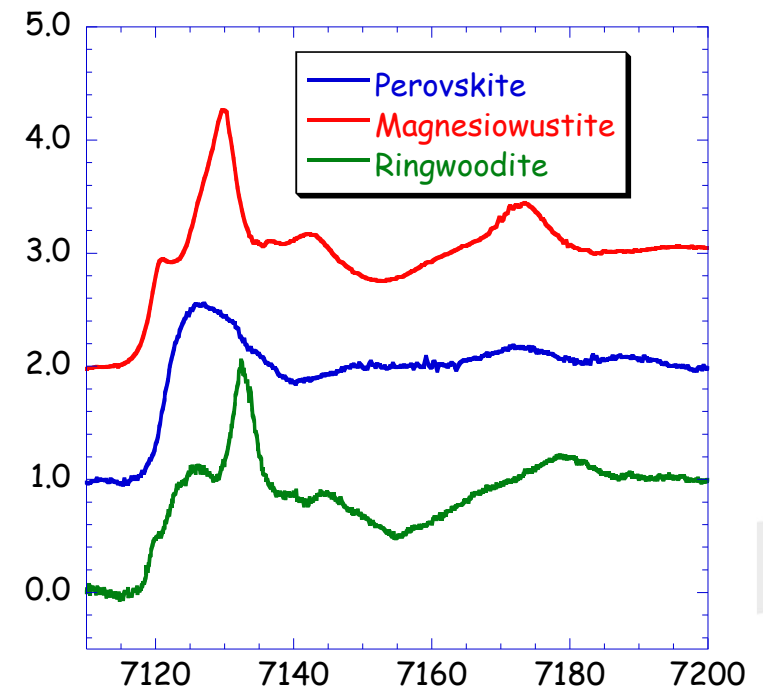



- ◆ Introduction
- ◆ Effects of pressure
 - ◆ Insulator to metal transitions
 - ◆ Metal to insulator transitions
 - ◆ Effects on magnetism
 - ◆ Structural phase transitions
- ◆ High pressure and Earth's science
- ◆ Tools and methods
- ◆ Examples of high pressure research using XAS
 - ◆ Polyamorphism in glassy GeO_2
 - ◆ Melting of iron at megabar pressures
 - ◆ Revealing Earth's interior
- ◆ **Bibliography**

◆ Chapter 29 of

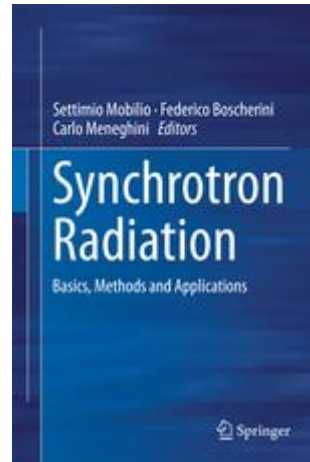

◆ General overview on the effects of pressure:

- ◆ W. Crochala, R. Hoffman, J. Feng, N. W. Ashcroft. *The Chemical Imagination at Work in Very Tight Places*. *Angew. Chem. Int. Ed.* 2007, **46**, 3620 – 3642.
- ◆ R. J. Hemley and N.W. Ashcroft. *The revealing role of pressure in condensed matter sciences*. *Physics Today* 1998, **51(8)**, 26-32.

◆ Insulator to metal transitions

◆ Silicon

- ◆ S. Minomura and H. G. Drickamer. *Pressure induced phase transitions in silicon, germanium and some III-V compounds*. Phys. Chem. Solids 1962, **23**, 451-456

◆ Indium arsenide

- ◆ S. Pascarelli, G. Aquilanti, W. Crichton, T. Le Bihan, S. De Panfilis, E. Fabiani, M. Mezouar, J.P. Itié, A. Polian. *High pressure x-ray absorption and diffraction study of InAs*. High Pressure Research 2002, **22**, 331-335.
- ◆ G. Aquilanti, W. A. Crichton, T. Le Bihan, S. Pascarelli. *High-pressure X-ray diffraction study of InAs*. Nuclear Instruments and Methods in Physics Research B 2003, **200**, 90–94.
- ◆ S. Pascarelli, G. Aquilanti, W. A. Crichton, T. Le Bihan, M. Mezouar, S. De Panfilis, J. P. Itié, A. Polian. *Observation of the high-pressure Pmma phase in InAs: A combined X-ray absorption and diffraction study*. Europhys. Lett. 2003, **61** (4), 554–560.
- ◆ G. Aquilanti and S. Pascarelli . *EXAFS study of the local structure of InAs up to 80 GPa*. J. Phys.: Condens. Matter 2005, **17** 1811–1824.

◆ Insulator to metal transitions

◆ Bromine

- ◆ A. San-Miguel, H. Libotte, M. Gauthier, G. Aquilanti, S. Pascarelli, J.-P. Gaspard. *New Phase Transition of Solid Bromine under High Pressure*. Physical Review Letters 2007, **99**, 015501.
- ◆ A. San-Miguel, H. Libotte, J. P. Gaspard, M. Gauthier, A. Polian, J. P. Itié, *Bromine metallization studied by X-ray absorption spectroscopy*. Eur. Phys. J. B 2000, **17**, 227.

◆ Hydrogen

- ◆ H. K. Mao and R. J. Hemley. *Ultrahigh-pressure transitions in solid hydrogen*. Rev. Mod. Phys. 1994, 66, No. 2, 671-692. (cited 385 times on September 21st 2015)

◆ Insulator to superconductor transitions

◆ Oxygen

- ◆ K. Shimizu, K. Suhara, M. Ikumo, M. I. Eremets, K. Amaya. *Superconductivity in oxygen*. Nature 1998, **393**, 767-769.

◆ Metal to insulator transitions

◆ Sodium

- ◆ Y. Ma, M. Eremets, A. R. Oganov, Y. Xie, I. Trojan, S. Medvedev, A. O. Lyakhov, M. Valle, V. Prakapenka. *Transparent dense sodium*. Nature 2009, **458**, 182-185.

◆ Pressure effects on magnetism

- ◆ R. Torchio, O. Mathon, S. Pascarelli. *XAS and XMCD spectroscopies to study matter at high pressure: Probing the correlation between structure and magnetism in the 3d metals*. Coordination Chemistry Reviews 2014, **277**, 80-94.

◆ Phase transitions

◆ Arsenic

- ◆ H. J. Beister, K. Strössner, and K. Syassen. *Rhombohedral to simple-cubic phase transition in arsenic under pressure*. Phys. Rev. B 1990, **41**, 5535.

◆ Europium

- ◆ R. J. Husband, I. Loa, K. A. Munro, E. E. McBride, S. R. Evans, H.-P. Liermann, and M. I. McMahon. *Incommensurate-to-incommensurate phase transition in Eu metal at high pressures*. Phys. Rev. B 2014 **90**, 214105.

◆ Osmium

- ◆ L. Dubrovinsky, N. Dubrovinskaia, E. Bykova, M. Bykov, V. Prakapenka, C. Prescher, K. Glazyrin, H.-P. Liermann, M. Hanfland, M. Ekholm, Q. Feng, L. V. Pourovskii, M. I. Katsnelson, J. M. Wills, I. A. Abrikosov. *The most incompressible metal osmium at static pressures above 750 gigapascals*. Nature 2015, **525**, 226-229.

◆ Earth's science

- ◆ D. Antonangeli, J. Siebert, J. Badro, D. L. Farber, G. Fiquet, G. Morard, F. J. Ryerson. *Composition of the Earth's inner core from high-pressure sound velocity measurements in Fe-Ni-Si alloys*. Earth and Planetary Science Letters 2010, **1-2**, 292-296.

◆ DAC for ultra-high pressures

- ◆ L. Dubrovinsky, N. Dubrovinskaia, V. B. Prakapenka, A. M. Abakumov. *Implementation of micro-ball nanodiamond anvils for high-pressure studies above 6 Mbar*. NATURE COMMUNICATIONS | DOI: 10.1038/ncomms2160

◆ Iron melting

- ◆ G. Aquilanti, A. Trapananti, A. Karandikar, I. Kantor, C. Marini, O. Mathon, S. Pascarelli, R. Boehler. *Melting of iron determined by X-ray absorption spectroscopy to 100 GPa.*

www.pnas.org/cgi/doi/10.1073/pnas.1502363112

◆ Chemical reactions

- ◆ G. Aquilanti, S. Pascarelli, O. Mathon, M. Muñoz, O. Narygina, L. Dubrovinsky. *Development of micro-XANES mapping in the diamond anvil cell.* J. Synchrotron Rad. 2009, 16, 376–379